



**US Army Corps  
of Engineers ®**

# **LEVEE OWNER'S MANUAL FOR NON-FEDERAL FLOOD CONTROL WORKS**

**THE REHABILITATION AND INSPECTION  
PROGRAM**

**PUBLIC LAW 84-99**



---

**MARCH 2006**



**IMPORTANT QUICK REFERENCE INFORMATION  
CONCERNING THIS PROJECT:**

1. **PROJECT NAME:** \_\_\_\_\_

2. **IDENTIFICATION NUMBER/CWIS NUMBER:** \_\_\_\_\_

3. **RIVER:** \_\_\_\_\_

4. **PROJECT LOCATION**

**CITY/COUNTY:** \_\_\_\_\_

**TOWNSHIP/SECTION:** \_\_\_\_\_

5. **PUBLIC SPONSOR:** \_\_\_\_\_

6. **ARMY CORPS OF ENGINEERS DISTRICT OFFICE**

**LOCATION:** \_\_\_\_\_

**TELEPHONE NUMBER:** \_\_\_\_\_

7. **EMERGENCY POINT OF CONTACT FOR THE ARMY CORPS OF ENGINEERS**

**NAME:** \_\_\_\_\_

**TELEPHONE NUMBER:** \_\_\_\_\_

**CELL PHONE NUMBER:** \_\_\_\_\_

8. **COUNTY EMERGENCY OPERATIONS CENTER:** \_\_\_\_\_

9. **STATE EMERGENCY OPERATIONS CENTER:** \_\_\_\_\_



## PREFACE

This manual was written specifically for the local, state, or tribal governments that have the primary responsibility for operating and maintaining flood control works. The intent of the document is to provide you, the public sponsor of a flood control system, with some clear and comprehensive guidance on the operation and maintenance of levees, floodwalls, and other flood control structures. It describes how to plan and prepare for high water, and lays out steps to take during emergencies that will help reduce the threat of flooding. It also touches upon other related components of a complete flood protection program, such as how you might promote public awareness of local flood issues.

In addition to providing recommendations on how to make your flood control programs more effective, this manual also explains the types of assistance that the U.S. Army Corps of Engineers can provide to a community before, during, and after a flood. We hope the information presented will make the emergency programs we administer more clear and accessible.

One of these programs referenced throughout this manual is the Rehabilitation and Inspection Program. Through this program, the Corps helps communities rehabilitate flood control projects that become damaged in a flood. These types of repairs are often so costly that they would be difficult for a community to complete without assistance from the federal government. In order for communities to participate and benefit from this program, they need to properly maintain the flood control project and prepare for high water. One of the primary purposes of this manual is to clearly explain the minimum requirements that the Corps has established for participation in this program. The Corps will verify that the basic requirements are met through routine inspections. These inspections are not intended to be a burden, but to help you identify potential problems and properly maintain your infrastructure so that your community is better protected from floods.

Without a firm understanding of the details or requirements of a flood control system, many people tend to take the protection provided by the flood control project for granted. Floodwalls tend to blend in with the scenery in industrial areas and levee slopes are used for concerts and picnics. While there isn't anything wrong with this, it makes it easy to lose sight of the true significance of these structures. There are intricacies to these systems that require detailed knowledge for operation and maintenance, and many tasks that need to be carefully coordinated during high water. A flood protection system simply cannot be relied upon if it hasn't been properly maintained or if people aren't trained and ready to operate it during high water.

As a public sponsor of a flood control project, you should be prepared to carry out maintenance activities on your flood control structures every year. Regular maintenance is critical, because many types of problems will escalate exponentially when left unchecked. There are many ongoing requirements of which you should be aware. For example, debris and unwanted growth needs to be removed from levees, riprap, the areas adjacent to floodwalls, and from channels. An animal control program is needed on levees, and any burrows that are

found need to be filled properly. Metal gates and other components need to be painted and greased periodically. Concrete damage needs to be identified and repaired early or it will get worse, especially in northern climates where freeze-thaw damage becomes a factor. Beyond these examples of ongoing maintenance, there are also more significant repairs that will be necessary from time to time. Sometimes, you may have to add stone to control an erosion problem, or do some major earthwork to repair an embankment. Metal culverts running through a levee will have to be completely replaced from time to time, because they typically don't last more than about fifty years. Pump stations also need to be completely overhauled periodically. Don't let these larger repairs take you by surprise, as they are to be routinely expected in any project, and you can plan for them in advance.

You can also plan and prepare for what you are going to do when there is high water. A listing of the various activities you might have to coordinate is presented in this manual, but this list is not exhaustive, and it is not designed to be used by itself. As the public sponsor, you are responsible for developing and maintaining a basic flood response plan. You may wish to start with the general information presented here, but a lot of details such as likely location of sand boils, key personnel, and the location of closings, gates and other important project features should be collected and clearly documented in one place. Plans need to be tested, personnel need to be trained; and necessary supplies such as sandbags and plastic sheeting need to be maintained for emergency use.

The proper operation and maintenance of a flood control system is a challenging and complex responsibility, but is vital to communities that have been constructed within the flood plain. When the water rises, it can be quite sobering when one realizes that the river on the other side of a floodwall or levee is actually flowing above the ground level, and that a simple wall or levee is the only thing keeping it from crashing down and filling your streets. This is when all of your maintenance and vigilant preparation pays off.

## **ACKNOWLEDGEMENTS**

This publication is the collaborative effort of all Corps divisions and districts, largely written and compiled by the U.S. Army Corps of Engineers' Office of Homeland Security, Emergency Management Branch in Washington, DC. Special thanks go to the Department of Environmental Protection in the State of Pennsylvania for allowing the Corps to use material from their Handbooks for Operating, Maintaining, and Monitoring Flood Protection Projects. We would like to thank all of the state agencies and public sponsors of flood control works that have contributed to the material presented.

# TABLE OF CONTENTS

<b>1.</b>	<b>INTRODUCTION .....</b>	<b>1</b>
1.1	Purpose of This Manual .....	1
1.2	Scope of This Manual .....	1
1.3	Supporting and Related Laws and Regulations .....	1
1.4	Reproduction.....	3
1.5	Future Revisions .....	3
1.6	Disclaimer .....	3
<b>2.</b>	<b>MAINTENANCE OF PROJECT FEATURES .....</b>	<b>5</b>
2.1	Introduction.....	5
2.2	Erosion (Applicable to all FCWs) .....	6
2.3	Encroachments (Applicable to all FCWs) .....	7
2.4	Slope Stability (Applicable to all FCWs) .....	9
2.5	Removal of Debris (Applicable to all FCWs) .....	11
2.6	Animal Control (Applicable to all FCWs).....	11
2.7	Riprap Revetments and Banks (Applicable to all FCWs) .....	13
2.8	Vegetation (Levee Specific) .....	16
2.9	Cracking (Levee Specific) .....	18
2.10	Ruts and Depressions (Levee Specific) .....	19
2.11	Underseepage Control Berms (Levee Specific).....	20
2.12	Excavations (Levee Specific) .....	20
2.13	Utilities (Levee Specific) .....	20
2.14	Underseepage Relief Wells/ Toe Drainage (Levees and Floodwalls) .....	21
2.15	Seepage/ Sandboils (Levees and Floodwalls).....	21
2.16	Closure Structures (Levees and Floodwalls) .....	22
2.17	Concrete Surfaces (Applicable to all concrete structures).....	22
2.18	Tilting, Sliding, and Settlement (Applicable to all Concrete Structures) .....	25
2.19	Vegetation (Floodwall specific).....	26
2.20	Internal Drainage Systems .....	26
2.21	Pump Stations .....	31
2.22	Flood Control Rivers and Channels.....	32
2.23	Concrete Lined Channels.....	33
2.24	Debris Basins .....	33
2.25	Floodways .....	34
<b>3.</b>	<b>FLOOD PREPAREDNESS .....</b>	<b>35</b>
3.1	Flood Fight Equipment and Supplies.....	35
3.2	Plans.....	38
3.3	Training and Exercises.....	40
3.4	Relations with Local and State Partners .....	41



<b>4.</b>	<b>ACTIONS DURING HIGH WATER EVENTS .....</b>	<b>43</b>
4.1	Phase I: Preliminary Response Activities .....	43
4.2	Phase II: Full Response Activities .....	49
4.3	Evacuation Plans.....	50
4.4	After the Event.....	51
<b>5.</b>	<b>ADDITIONAL SPONSOR RESPONSIBILITIES .....</b>	<b>53</b>
5.1	Annual Pre-Flood-Season Inspections.....	53
5.2	Public Awareness Activities .....	53
5.3	Awareness of Adjacent Systems.....	54
5.4	Permits .....	54
5.5	Records .....	55
<b>6.</b>	<b>REHABILITATION AND INSPECTION PROGRAM (RIP) .....</b>	<b>57</b>
6.1	Overview of the Rehabilitation and Inspection Program.....	57
6.2	Projects that Qualify .....	58
<b>7.</b>	<b>CORPS INSPECTIONS.....</b>	<b>61</b>
7.1	Entering the RIP – The Initial Eligibility Inspection (IEI) .....	61
7.2	Maintaining Active Status – Continuing Eligibility Inspections (CEIs) .....	62
7.3	Inspection Methodology .....	63
<b>8.</b>	<b>REHABILITATION ASSISTANCE.....</b>	<b>65</b>
8.1	Requesting Rehabilitation Assistance.....	65
8.2	Requirements for Receiving Rehabilitation Assistance.....	65
8.3	Cooperation Agreements .....	66
8.4	Nonstructural Alternatives to Rehabilitation .....	69
<b>9.</b>	<b>OTHER TYPES OF ARMY CORPS OF ENGINEERS EMERGENCY ASSISTANCE .....</b>	<b>71</b>
9.1	Technical Assistance.....	71
9.2	Direct Assistance .....	72
9.3	Advance Measures Assistance.....	72
9.4	Post Flood Assistance .....	73
9.5	Emergency Water Assistance .....	73

## **APPENDICES**

APPENDIX A: Acronyms and Definitions

APPENDIX B: Flowchart of RIP Eligibility and Inspection Processes for Non-Federal FCWs

APPENDIX C: FCW Inspection Guide

APPENDIX D: Flood Fighting Techniques on Levees

APPENDIX E: Rehabilitation Request Form

APPENDIX F: Cooperation Agreement for Rehabilitation of Non-Federal Flood Control Works

APPENDIX G: Cooperation Agreement for Flood Fight

APPENDIX H: Cooperation Agreement for Advance Measures Assistance

APPENDIX I: Useful Internet Addresses

# 1. INTRODUCTION

## 1.1 Purpose of This Manual

The purpose of this manual is to provide public sponsors of non-Federally constructed and maintained flood control projects with a single reference that describes proper operation and maintenance of flood control projects, and outlines the types of assistance the U.S. Army Corps of Engineers can provide before, during, and after a flood. This manual provides information regarding the Corps' Rehabilitation and Inspection Program (RIP), and explains the minimum standards for operation and maintenance that the Corps requires of non-federal flood control projects, in order for them to be eligible for the Corp's rehabilitation assistance after a flood. However, since the procedures described are considered to be the minimum guidelines for proper maintenance of any flood control project, the manual is a useful reference for all public sponsors of flood control projects regardless of their status or involvement in the RIP.

The publication of this manual was directed by Public Law 104-303, the Water Resources Development Act of 1996. It covers more than just levees, but it's called a *Levee Owner's Manual* because of the statutory wording in this law.

## 1.2 Scope of This Manual

This Levee Owner's Manual is intended for general use by public sponsors of existing non-federally constructed flood control works (FCWs) throughout the United States. Because of the wide range of FCWs, from small channels to large levees, it doesn't cover the detailed operation and maintenance of all project-specific features or the necessary steps to respond to specific situations such as ice jam flooding. Also, it only covers the operation and maintenance of FCWs that are already completed, rather than the engineering design and construction of new ones or new modifications. Corps inspections may address specific features that aren't specifically covered in this manual. For supplementary information on the operations and maintenance of Corps programs, specific features of your project, or specific situations, please contact your Corps district's Emergency Management Office.

## 1.3 Supporting and Related Laws and Regulations

In addition to presenting practical guidance on the operation and maintenance of flood control projects, this manual gathers together a lot of information from official laws and Corps regulations. Though every effort was made to present this information as accurately as possible, this manual itself is not meant to establish policy or official guidance. For additional details on the policies described and to find the actual wording given in the laws and regulations summarized in this manual, the reader is referred to the following documents:

**a. Public Law (PL) 84-99**

This is the federal law which gives the Corps the legal authority to supplement local efforts in the repair of flood control projects that are damaged by floods. It can be found on the web at <http://uscode.house.gov>. Click on the link to “Search the US Code.” Search for title “33” and chapter “15”. Look through the search results, and the current form of PL 84-99 will be listed as 33 USC 701n.

**b. Title 33, Code of Federal Regulations, Part 203 (33 CFR 203)**

This federal regulation establishes the Rehabilitation and Inspection Program (RIP), describes the types of assistance the Corps can provide, and describes the general operation, maintenance, and disaster preparedness that is expected of non-federal flood control works. The current version of the CFR can be accessed through the CFR main page, <http://www.gpoaccess.gov/cfr/index.html>. Select “Browse and/or search the CFR,” then scroll down to the current version of Title 33, (Navigation and Navigable Waters). Browse parts 200-399; then open part 203.

**c. Title 33, Code of Federal Regulations, Part 208 (33 CFR Part 208):**

This federal regulation provides more specific details on the operation and maintenance required of Federally constructed FCWs. This regulation provides a guideline for O&M, but doesn’t provide the level of detail regarding specific requirements that the Levee Owner’s manual does. The current version of the CFR can be accessed through the CFR main page, <http://www.gpoaccess.gov/cfr/index.html>. Select “Browse and/or search the CFR,” then scroll down to the current version of Title 33, (Navigation and Navigable Waters). Browse parts 200-399; then open part 208.

**d. Engineer Regulation (ER) 500-1-1**

This Corps-wide regulation expands on the previously mentioned laws and regulations, provides basic information on the Corps’ implementation of Public Law 84-99. Chapter 5 of ER 500-1-1 details the RIP program. Any discrepancies or conflicts that occur between the Levee Owner's Manual and ER 500-1-1 will be resolved based on the content of ER 500-1-1. This document can be found on the web at <http://www.usace.army.mil/inet/usace-docs/eng-regs/er500-1-1/toc.htm>

**e. Engineer Pamphlet (EP) 500-1-1**

This Corps-wide pamphlet provides further detail on how the ER will be applied practically. It establishes the Inspection Guide and other applicable forms that are listed in the appendices to this manual. Any discrepancies or conflicts that occur between the Levee Owner's Manual and any EP or ER will be resolved based on the content of the ER or EP, and any discrepancies or conflicts that occur between the EP and the ER will be resolved based on the content of the ER. EP 500-1-1 can be found on the web at <http://www.usace.army.mil/inet/usace-docs/eng-pamphlets/ep500-1-1/toc.htm>

**f. Engineer Manual (EM) 1110-2-1913**

This manual provides the Corps of Engineer's guidelines for engineering design and construction of levees. The document can be found at <http://www.usace.army.mil/inet/usace-docs/eng-manuals/em1110-2-1913/toc.htm>

**g. Engineer Manual (EM) 1110-2-301**

This manual provides guidelines for landscape planting at Floodwalls, Levees, and Embankment Dams. This document provides additional clarification as to which types of vegetation are acceptable on and around flood control works. This can be found at <http://www.usace.army.mil/inet/usace-docs/eng-manuals/em1110-2-301/toc.htm>

**h. Engineer Manual (EM) 1110-2-2705**

This manual provides guidance on the design of closure structures for local flood control projects. It can be found on the web at <http://www.usace.army.mil/inet/usace-docs/eng-manuals/em1110-2-2705/toc.htm>

**i. Engineer Manual (EM) 1110-2-1205**

This manual provides information regarding environmental engineering for flood control channels. This EM can be found at <http://www.usace.army.mil/publications/eng-manuals/em1110-2-1205/toc.htm>

#### **1.4 Reproduction**

The material presented is not copyrighted and can be reproduced as needed. This and similar materials can be downloaded from <http://www.usace.army.mil/inet/functions/cw/cecwhs/em/fcw/fcw.html> Send inquiries to the U.S. Army Corps of Engineers Headquarters, Emergency Management Branch, 441 G St NW, Washington, DC, 20314. Send inquiries to [CECW-HS@USACE.ARMY.MIL](mailto:CECW-HS@USACE.ARMY.MIL) The Corp's 24-hour emergency telephone number is 202-761-1001.

#### **1.5 Future Revisions**

There are no scheduled future revisions of this manual. However, as Corps districts and divisions revise and improve upon various sections of this text, it is requested that these revisions be provided to the Office of Homeland Security in Corps Headquarters, so that the most current and accurate information can be presented on the Corps website and shared with other districts. The Corps would also make use of any updated or corrected information when compiling similar manuals in the future.

#### **1.6 Disclaimer**

Nothing in this manual creates any liability of the United States or its officers or employees for the recovery of damages caused by an action or failure to act; or relieves the owner or operator of a Flood Control Work of any legal duty, obligation or liability incident to the ownership or operation of the Flood Control Work.

This page intentionally left blank.

## 2. MAINTENANCE OF PROJECT FEATURES

### 2.1 Introduction

All flood control works (FCWs) must be properly maintained to provide the protection for which they were designed. Remember that as the public sponsor, you are solely responsible for ensuring that the FCW is properly maintained and will protect the lives and property of your families, friends, and taxpayers. Even if you have sub-agreements with local landowners who routinely perform project maintenance, these landowners are not ultimately responsible for the operations and maintenance of the FCW. If landowners fail to perform needed maintenance or correct deficiencies on their property, it's your duty to ensure that the maintenance and repairs are completed. Proper maintenance of the FCW must be taken very seriously, and local plans and budgets need to be structured so that the maintenance of each project feature is carried out on a regular and continual basis. In addition to providing for usual operations and maintenance expenses, this budget needs to account for the replacement of more expensive project components such as pumps, motors, gates, and corrugated metal pipes as they age and come to the end of their design life.

This chapter identifies many of the activities that are necessary to maintain flood control works. The following sections provide maintenance recommendations, requirements, and examples of the types of deficiencies that will reduce the project's eligibility status within the Rehabilitation and Inspection Program (RIP), which is described in chapter 6. To avoid confusion between the baseline requirements that the U.S. Army Corps of Engineers has established for inclusion in the RIP and the additional suggestions and recommendations that are provided in this chapter, please refer to the Corps' Inspection Guide, found in Appendix C. The Inspection Guide is used in Corps inspections of all non-Federally constructed FCWs, and lists the specific requirements for inclusion in the RIP. This listing is not all-inclusive and some Corps districts may specify additional requirements based on local conditions. More information on Corps inspections is provided in chapter 7.

Note that many of the pictures in this chapter are labeled with the words "*ACCEPTABLE*", "*MINIMALLY ACCEPTABLE*" and "*UNACCEPTABLE*." The ratings are provided here along with the pictures in order to give you a better understanding of the standards that the Corps uses while inspecting flood control works across the country. The ratings given are the ones that a Corps inspector might assign to the project feature if it was observed during a routine inspection. A definition of these ratings is provided in chapter 7.

## 2.2 Erosion (Applicable to all FCWs)

### a. Types of Erosion

There are several types of erosion that effect FCWs. For example, the slopes of any embankment can become eroded from rain runoff, as shown in Figure 2.1 or by embankment overtopping, as in Figure 2.2. Depending on the extent of the erosion, the level of protection provided by the FCW can be significantly reduced. In cases of embankment overtopping during a flood, there may be a total failure of the structure.

A second type of erosion often seen on embankments is wave wash. Under high water conditions, wave action can form long terraces along the length of the embankment slopes. If additional material or bank protection is not provided, the embankment will continue to cave as the waves work their way farther into the slope. Further discussion on the treatment of wave wash is provided in Appendix D of this manual.

A third type of embankment erosion is caused by the flow of water within a river or channel. These flows can erode a channel bank or levee, or undermine other flood control structures and cause them to cave into the water. Bank caving or stream bank erosion can be a very serious threat to the stability of an FCW. It's critical that the riverward bank be inspected for bank caving or erosion. If the river or stream bank erosion or caving is observed to be moving in the direction of a levee or floodwall, immediate action should be taken to stabilize the banks.

### b. Repair of Areas Damaged by Erosion

All erosion gullies like those pictured in 2.1 need to be repaired to prevent further erosion and more significant damage during high water. The ground should be scarified and backfilled with the same type of material that the levee is made of. The backfill material should generally be placed in 6 inch layers and compacted mechanically or by hand, in order to restore the original shape of the levee. Additionally, since this erosion is typically a reoccurring problem, something should be done to improve the drainage and prevent further erosion in the area. Consideration



**Figure 2.1** *UNACCEPTABLE erosion of levee slope. (TX)*



**Figure 2.2** *Flood damage. (WA)*



**Figure 2.3** *Slope failure on bank protection project. (WA)*



should be given to installing drainage channels or appropriately sized rock, and areas of the levee that remain exposed should be reseeded and mulched. Please refer to section 2.7, below, for details on the placement of riprap. In extreme cases of channel/bank erosion, a relocation or setback of the levee may be the only economical solution.

### 2.3 Encroachments (Applicable to all FCWs)

Excavations, structures, or other obstructions present within the project easement area are generally prohibited. Fencing that prohibits access along the crown of the levee is prohibited. Where access control is needed, the public sponsor should install gates that will allow continued access along the crown of the levee for surveillance and flood fight activities. The Corps may make certain exceptions to this rule, provided the encroachment does not impact the operation, maintenance, or structural integrity of the project. Figures 2.5 through 2.14 are examples of common encroachments that should not be permitted.



**Figure 2.4** *ACCEPTABLE.* Landowner has not encroached on levee easement area and has stayed back 10 - 15 feet. (MN)



**Figure 2.5** *MINIMALLY ACCEPTABLE.* Field encroaches on levee easement. The landowner has tilled the soil right to toe of the levee, and was requested to stay back at least 10 feet. (ND)



**Figure 2.6** *UNACCEPTABLE* levee encroachments. This landowner tilled near one third of the way up the landward levee slope. (MN)



**Figure 2.7** UNACCEPTABLE levee encroachments. Utility poles in levee embankment. (IN)



**Figure 2.8** UNACCEPTABLE encroachment. Piping for lawn irrigation system drilled through levee without approval. (ND)



**Figure 2.9** UNACCEPTABLE encroachments on earthen levee. Fallen woody debris requires removal. (KS)



**Figure 2.10** UNACCEPTABLE, unapproved encroachment. Material stockpiled against the levee. (OK)



**Figure 2.11** UNACCEPTABLE encroachment. Residential and rural fences crossing the levee. (ND)



**Figure 2.12** UNACCEPTABLE, unapproved encroachment on levee easement (fencing). (OK)



**Figure 2.13** UNACCEPTABLE encroachment. Gardens and compost bins located on levee crest and riverward slope. (ND)



**Figure 2.14** UNACCEPTABLE encroachment. Patio construction using railway timbers and fill without approval. (ND)

## 2.4 Slope Stability (Applicable to all FCWs)

Some earthen materials tend to become saturated with water very easily. When this happens, they lose stability and can't support their own weight. If a stream or river embankment is composed of these materials, the embankment will slump off and move down the slope into the river, causing a bulge at the base of the slope. When river banks break down like this, they are said to have slope stability problems and need to be repaired. Slope failures can lead to serious problems, especially if the failure occurs near a levee or floodwall. Figures 2.15 through 2.17 show examples of slope stability problems.



**Figure 2.15 UNACCEPTABLE.** Slope failure and erosion caused by inadequate channel bottom and side slope protection. This was a direct result of bottom scouring that undercut the levee slope and erosion caused by turbulent flow at the end of the bank protection. (ND)



**Figure 2.16 UNACCEPTABLE.** Slope failure and erosion on a channel improvement project. (MN)

Levees, like riverbanks, are subject to the same soil saturation effects during a flood or period of heavy rainfall. Levees are generally less susceptible to slope stability problems because of the materials they are made of and because of their shallow slopes. However, slope failures have occurred during prolonged periods of high water or heavy rainfall. Figure 2.16 shows an earthen embankment that failed as floodwaters receded. While slope failures will generally occur on the riverward slope of a levee, be aware that slope failures on landward slopes are also possible. A levee should be carefully inspected for slope stability problems after these events.



**Figure 2.17 UNACCEPTABLE** earthen embankment failure. (MN)



A related slope failure/ stability problem involves trees growing on or near the channel or levee slopes. It's very important to prevent tree growth near levee or channel embankments, because when the roots of these trees decay they leave voids in the soil, which allow water to quickly saturate the slope and cause a slope failure. Trees can also be uprooted and deflect flood flows into the embankment, accelerating the erosion of the bank.

**Figure 2.18** *Classic picture of a tree causing slope failure. (WA)*

The classic signs of slope stability problems are listed below, and you should watch for these signs during routine inspections.

- a. Wide deep cracks that parallel the riverbank or levee crest. In the case of levees, these cracks may also extend down the slope of the levee.
- b. Vertical movement of the material along the crack. Remember that this movement may be very obvious like in Figures 2.16 or 2.17, or very subtle if the stability problem is just starting to develop.
- c. If the slope has slumped or is starting to slump, examine the area along the toe of the embankment. In many cases there will be a noticeable bulge in the slope or riverbank.

Please also refer to section 2.9 for further discussion on levee cracking.

Deep seated sliding often requires the removal and replacement of that section of the levee or river slope, and the stabilization of the area with a soil or rock berm. If you identify signs of a developing slope stability problem, it is very important that you contact your local Corps district office for an investigation and to get technical assistance as to the best way to repair the problem.

## 2.5 Removal of Debris (Applicable to all FCWs)

Any accumulations of drift, grass clippings, and other objectionable materials deposited on the riverward side of any FCW or along the crown and side slopes of a levee must be removed and disposed of at suitable locations outside of the floodway. When debris collects in a flowing



**Figure 2.19** UNACCEPTABLE erosion of river channel, caused by a log jam. (ND)

channel, it can deflect the water towards the channel bank, causing significant damage to the FCW. Figure 2.19 shows the result of what started out as a beaver dam that was not removed, which expanded into a log jam. Before this log jam was removed, both the inside river bank and the levee experienced severe bank erosion. Log jams have endangered bridges and railway crossings, and they lead to higher flood crest elevations upstream of the obstruction.

One common problem experienced along urban levees is that the residents pile lawn clippings and yard waste on the riverward side of the levee. This practice should not be allowed because the clippings will kill the grass cover that protects the levee. During a flood, the debris gets washed away, exposing the levee material to erosion.

## 2.6 Animal Control (Applicable to all FCWs)

Close attention must be given to the presence of burrowing animals, since they may not be readily detected without a thorough inspection. Burrows created by gophers, muskrats, opossums, badgers, and other animals can lead to rapid levee failures during floods. For this reason, an active animal abatement program needs to be implemented to remove these animals. Rodent control techniques involving fumigation, bait stations, bait broadcasting, or trapping have proven effective in certain situations, but you should always contact your state's Fish and Game Agency, Department of Natural Resources, or Wildlife Agency to determine which rodent control procedures are allowable and recommended in your area.



**Figure 2.20** Animal burrow in a levee. (IA)

Inspections to detect the presence of burrowing animal activity are generally most effective immediately after the levee has been mowed. Animal burrows that are identified should be thoroughly excavated and inspected, backfilled with compacted soil that is similar to material

of the levee, and reseeded. This will avoid the possibility of water piping through unfilled portions of the burrows during a flood.

Beavers pose an additional concern in streams and channel improvement projects. They have been known to cause problems by building dams, blocking culverts, and by burrowing into the stream bank to create a den. When beaver activity is noted, the beaver should be removed and the dam and blockages removed. Failure to correct the problem may result in increased bank erosion and slope stability problems in the area of the beaver den during periods of high water.



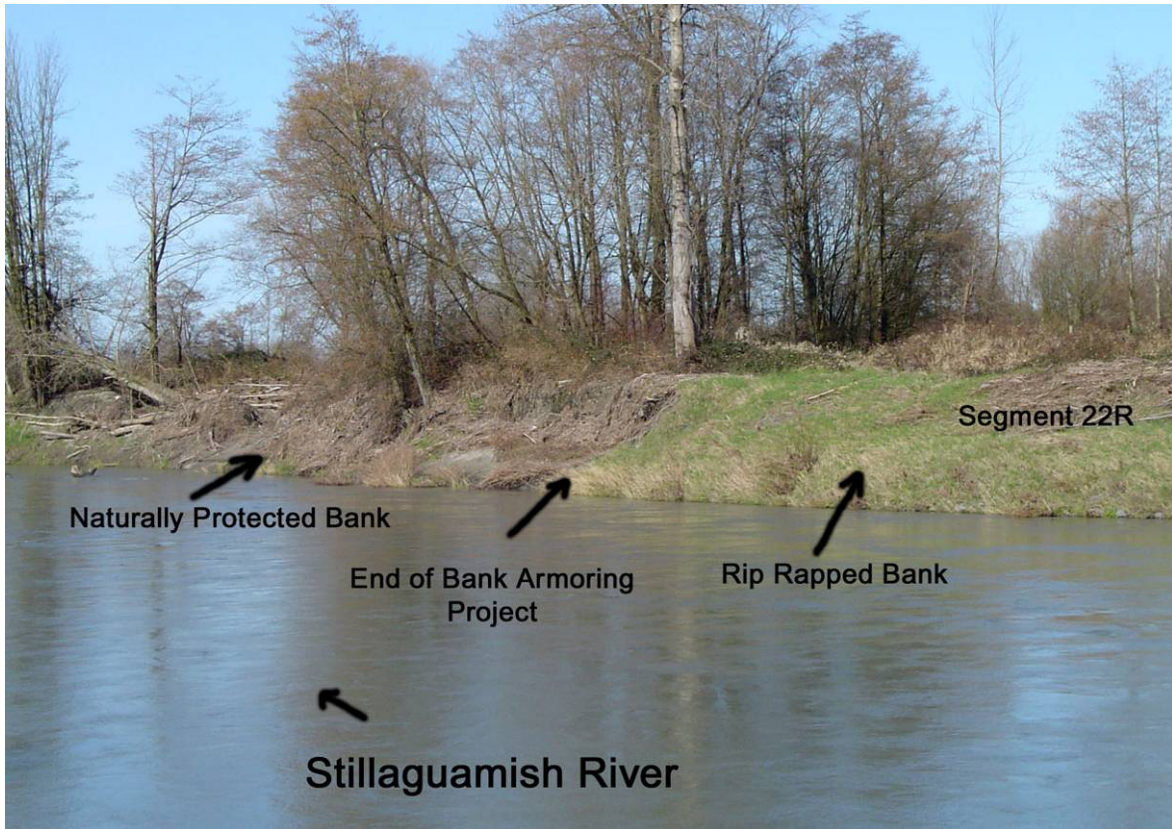
**Figure 2.21** Beaver dam. Such dams can stop flow within the channel and cause erosion to the channel banks. Sponsors are encouraged to remove beaver dams ASAP. (ND)



**Figure 2.22** Beavers attempting to block the culvert passing through a gated embankment. (MN)

## 2.7 Riprap Revetments and Banks (Applicable to all FCWs)

As shown in Figure 2.23, riprap can be a very effective method for protecting a riverbank or flood control feature from erosion. However, if the riprap protection is not placed correctly, it can cause eddy currents to erode unprotected areas of the bank upstream or downstream of the project, as shown in figure 2.24.



**Figure 2.23** Flood damage on a naturally protected bank, as compared to damage on an adjacent bank which was protected with riprap. (Note that even though the riprap clearly protected the area during the flood, if it was observed an inspection it would have probably been rated Minimally Acceptable because the grass would have prevented an inspector from properly examining the riprap.) (WA)



**Figure 2.24** Channel erosion located at the upstream end of a flood control levee protected by riprap. Erosion caused by riprap protection and eddy currents. (MN)

For riprap protection to be effective, it's important to ensure that it is properly maintained. During project inspections, look for settled areas that may indicate the riprap is being undermined by the river, ice, or debris. When undermining or rock displacement occurs, additional rock will need to be added to restore the even slope. When the rock protection is uneven the flow turbulence will increase, resulting in additional erosion of the project or of areas upstream or downstream of the project.

The protected area needs to be kept free of unwanted brush, saplings, and trees. Unwanted vegetation should be sprayed with an appropriate herbicide to kill the plant, and the root system should be removed. Failure to control the sapling and tree growth can result in the trees being uprooted during a flood, displacing the riprap and increasing the rate of erosion.



**Figure 2.25** ACCEPTABLE riprap for erosion control. (MT)



**Figure 2.26** ACCEPTABLE riprap for erosion control. (NE)



**Figure 2.27** MINIMALLY ACCEPTABLE. Trees and saplings are becoming established within riprap-protected areas and along the lower portions of the river channel, and must be removed. (ND)



**Figure 2.28** UNACCEPTABLE. Tree and sapling growth is well established within the riprap protection on an earthen levee. This overgrowth must be removed. (MO)

Any areas of stone riprap that have settled, moved, or been damaged by erosion should be filled in with hard, durable rock of suitable size or with a six-inch filter-blanket layer or a layer of geotextile fabric under the stone riprap, between the soil and the rock. These sublayers allow the water to pass from the soil, yet prevent the fine soil from washing out from under the



stone riprap. It's very important that you contact the Corps for technical assistance when installing geotextile fabrics, as the Corps has significant experience in installing riprap over geotextile fabric, and can help you to avoid complications with the process.

When selecting stone for riprap, choose durable rock that's insoluble in water. Stratified or easily crumbled rocks such as shale, or rocks such as claystones that are likely to decompose in water are not good for riprap. Stone for riprap should be block shaped with a specific gravity of at least 2.5. Smooth rounded stone or flat, thin, elongated and slab stones are not recommended. As a general rule, no more than 25% of the stones distributed throughout the gradation should have a length more than 2.5 times longer than the other dimensions, and none of the stones should be 3 times longer than their width or thickness.

Grouted riprap should be avoided unless it is absolutely necessary. The surface of grouted riprap can look perfectly fine until the bond between the grout and the rock fails. Grouted riprap can fail suddenly if it is undermined, and this can lead to unexpected and catastrophic failure of the slope. Other objections to using grout include the cost of installation, the lasting environmental impact, and the undesirable aesthetics of having a cement-lined stream bank as opposed to a plain rock bank.

It should be noted that work within a river channel which involves placing or adding material (soil or rock) may require a Section 404 permit from the Corps. Please contact your Corps district before placing any material along the banks of a river or stream to determine whether you will need a permit for the work. If the FCW is damaged by a flood or by high-water and is eligible for rehabilitation assistance under PL 84-99 as discussed in later chapters of this manual, the Corps will help you to obtain the necessary permits.

The Corps can provide recommendations or materials on the proper sizing, gradation, thickness, use of geotextile fabrics, and other details related to the placement of riprap.

## 2.8 Vegetation (Levee Specific)

The Corps' policy for landscaping around levees, floodwalls, and embankment dams, is found in EM 1110-2-301. The requirements are sometimes seen as being excessive and out of touch with contemporary environmental concerns, but as the primary function of a levee is to protect communities from flooding, the Corps' maintenance requirements have been established to reduce the chance of catastrophic failures during high water. If you'd like a variance to the Corps' vegetation requirements (allowing additional vegetation on or around the levee) then you need to contact your local Corps district. A variance would be granted if the proposed vegetation is seen to preserve, protect, or enhance natural resources, or if it protects the rights of Native Americans. Such variances will only be granted if the vegetation retains the safety, structural integrity, and functionality of the levee; retains the accessibility for inspection and flood fighting purposes; and doesn't reduce the level of protection required by the National Flood Insurance Program or the RIP if the levee is a part of these programs. Specific items relating to the maintenance of levee vegetation include the maintenance of the grass or sod cover and the removal of unwanted bushes and trees.

### a. Maintaining and Promoting a Good Grass or Sod Cover

Grass or sod cover is one of the most effective and economical means of protecting flood control levees and drainage swales against erosion caused by rain runoff, channel flows, and wave wash. As the public sponsor, you are required to ensure the grass cover has every opportunity to grow. This will require that you periodically fertilize, water, and mow the grasses as needed. In addition, every effort must be made to prevent unauthorized encroachments, grazing, vehicle traffic, the misuse of chemicals, or burning during inappropriate seasons. Failure to properly maintain the grass cover can result in unnecessary erosion and possible embankment failure.



**Figure 2.29** *MINIMALLY ACCEPTABLE.* This photo shows cattle grazing on the levee. Cattle typically don't harm the sod cover to the extent that sheep or other animals do. In this case, the landowner and the public sponsor were informed of the Corps' policy that grazing is not permitted on levees or within the levee easement area.

### b. Mowing

Periodic mowing is essential to maintaining a good ground cover. Levees should be mowed regularly in order to control weeds and to prevent the growth of brush and saplings. Long grasses and native prairie grasses are one of the many challenges facing the project inspector. Long grasses (greater than 12 inches in length) can make a visual inspection nearly impossible and can hide serious concerns such as rodent activity, levee slides, and cracking; all of which can lead to the failure of the levee. For these

reasons, the grass should be mowed to a minimum height of 3 inches. The last mowing of the season should be accomplished under conditions that will allow the grass to grow to approximately 8 to 10 inches by the winter season. It's important to ensure that the entire levee profile has been mowed, including zones extending 15 feet beyond the toes of the embankment, which should be free of all woody growth and should be clear of other obstructions so that a truck could drive beside the levee if needed.

### c. Control of Trees, Brush, and Weeds

If the public sponsor mows the levee at regular intervals, the growth of saplings, trees, and brush will not become a problem. However, if the levee is not mowed regularly, the resulting growth will make it difficult to properly maintain and inspect the project. Trees and brush can also affect the stability of the structure and interfere with emergency operations during high-water conditions. All trees and brush must be cleared and disposed of away from the flood control project. The disposal of material on the riverward

side of the levee or areas where flood waters can carry the material downstream is prohibited. In riprap protected areas, ditches, or in other areas of the project where power mowing is impractical, the unwanted vegetation should be controlled with an approved herbicide spray or should be cut by hand. Herbicides must be used in accordance with state and local laws and regulations. Any trees that reach 2 inches in diameter or greater, and are located on the levee, riprapped areas, drainage channels, or within 15 feet of the toe of the levee must be cut down, the root ball removed, the voids filled with impervious material, and the fill material firmly compacted and reseeded.



**Figure 2.30 UNACCEPTABLE** levee with knee-high grass, making visual inspection nearly impossible. (MN)



**Figure 2.31 UNACCEPTABLE.** Levee is mowed but trees and longer grasses within levee easement area. Trees are greater than 2" in diameter. (MN)



**Figure 2.32 UNACCEPTABLE** long grasses and trees on levee side slopes. (ND)

## 2.9 Cracking (Levee Specific)

It's important to closely monitor and evaluate all visible areas of cracking on a levee or riverbank, to ensure they don't develop slope stability problems as shown in Figure 2.35 and discussed in section 2.4. Cracks in a levee develop when the levee material is saturated with water and when it is overly dry. Clay, like most impervious materials, will shrink as it dries and re-expand when wet. Clay levee surfaces tend to shrink and expand slightly, and some cracks in the surface of the FCW are to be expected. Shrinkage cracks are generally narrow and shallow, not extending more than more than a few inches into the levee, but

during long periods of drought they may extend as much as two feet into the levee. These cracks can run longitudinally or transverse to the levee, as in Figure 2.33, or may appear as blocks as shown in Figure 2.34. If the cracking becomes excessive, it needs to be corrected even if the levee appears to be stable. It's important that you contact your local Corps district office for guidance on how to repair cracks observed in your levee.



**Figure 2.33** *ACCEPTABLE* cracking in clay levee with shrinkage cracking caused by dry conditions. (MN)



**Figure 2.34** *UNACCEPTABLE* cracking with landside pooling, Whitehead Levee Project, (IA)



**Figure 2.35** *UNACCEPTABLE* embankment cracking and slope failure. This photo shows what started out as cracking along the crest of the embankment and quickly developed into a slope failure. All cracking located on a levee or riverbank must be closely monitored. (MN)

## 2.10 Ruts and Depressions (Levee Specific)

Ruts and other depressions often develop along levees or patrol roads as a result of pedestrian or vehicular traffic, settlement, or because of an inadequate crown slope. Sometimes the levee material over a culvert can settle, leaving a trench across the crown of a levee. This process and related maintenance is discussed below in section 2.20. Ruts and depressions are a problem because they allow water to pond on the levee crest or access road. If left uncorrected, the ponded water will seep into the levee's interior or into roadway embankment, saturating the foundation material, and making the levee more susceptible to failure during a flood. The levee or access road should be inspected for ruts, pot holes, and areas of standing water after it rains.

To correct these problems, the topsoil and sod should be removed and the existing levee surface should be roughened. This is ideally done when the ground is not frozen; if there are ice crystals in the ground then the entire frozen layer should be removed. Loose fill material should be added evenly, in approximately 6 inch layers. Add water or dry the backfill materials as necessary to attain optimal moisture content during compaction. Compact in place by hand or mechanical methods in order to bring the levee back to its original shape. The topsoil should be replaced and the area should be reseeded and mulched for erosion control.

Figures 2.36 through 2.39 show common ruts that can hold water on access roads and levees.



**Figure 2.36** *MINIMALLY ACCEPTABLE* levee rutting caused by pedestrian and bicycle traffic. (ND)



**Figure 2.37** *UNACCEPTABLE* ruts in levee crown require fill. (MO)



**Figure 2.38** *MINIMALLY ACCEPTABLE* ponded water along a levee crest. (MN)



**Figure 2.39** *UNACCEPTABLE* rutting in levee. (OK)

When the crest of the levee is used for recreation, inspections, surveillance during floods, and flood fighting activities, a surface treatment (e.g., gravel, crushed rock, pavement, etc.) should be provided to reduce the deficiencies listed above. This is not a requirement but it is recommended for active levees.

### 2.11 Underseepage Control Berms (Levee Specific)

Underseepage control berms, also known as seepage berms, perform two functions in controlling seepage. First, they provide a downward weight to counteract the upward force of the seepage pressure within the foundation material adjacent to the levee, which is where the pressure is highest. Second, seepage berms lengthen the seepage path, which increases the flow resistance and decreases the seepage pressure in the area beyond the berm. The berms should be constructed with material at least as permeable as the existing levee to reduce the chance of increasing dangerous build up of hydrostatic pressures within the levee. They should be thoroughly inspected both before and after each flood along with the rest of the FCW, and any cracks, depressions, settlement, or other problems identified need to be repaired as outlined in previous sections of this chapter.

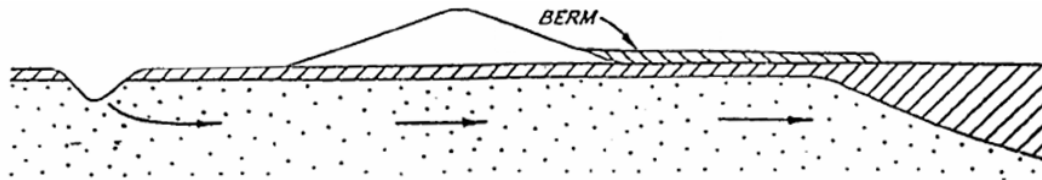


Figure 2.40 Sketch of a seepage berm.

### 2.12 Excavations (Levee Specific)

The removal of levee blanket materials may endanger the levee by increasing the potential for seepage or stability problems. Any excavation that is proposed within the boundaries of the levee easement or right-of-way should be reviewed by the Corps. This review may result in a recommendation to not allow the excavation, or to recommend restrictions on the excavation in order to maintain the project's eligibility for rehabilitation assistance. The areas the public sponsor should monitor for excavation activities include the levee itself, and those areas within 100 feet, both landward and riverward, of the levee.

### 2.13 Utilities (Levee Specific)

It's also recommended that you coordinate the construction of any utilities that cross over, under, or through levees or other flood control structures with the Corps prior to the start of construction. During the installation of the utility, care needs to be taken to ensure that pipes do not leak, and that there is adequate compaction around the utility. Failure to provide good compaction will allow for seepage along the pipe during a flood. Once installed, the utility trench will need to be monitored for cracks, depressions, settlement, sink holes, or saturated soils that may indicate a leak or possible seepage along the utility line. These types of problems should be brought to the utility company's attention as soon as they are discovered and repaired expeditiously. Additional guidance on the placement of utilities, excavations, and on other related topics can be found at

[http://www.nwk.usace.army.mil/local\\_protection/guidance.html](http://www.nwk.usace.army.mil/local_protection/guidance.html), as referenced in Appendix I of this manual. Your district office may be able to provide additional information, if needed.

#### **2.14 Underseepage Relief Wells/ Toe Drainage (Levees and Floodwalls)**

Relief wells are used to relieve hydrostatic pressures in the foundation of a levee, which is caused by fluctuation in the water table or seepage under a levee or flood control structure during a flood. Typical relief wells consist of a well screen, a filter pack (granular material surrounding the well screen), a riser, and an outlet system. Relief wells, over time, can become less efficient at relieving hydrostatic pressures because of clogging of the filter pack, sedimentation build up in the well screen, and/or bio-fouling. Clogging of the filter pack and sedimentation within the relief well occurs when the foundation material migrates into the filter pack, making it less permeable and reducing the well's effectiveness. Bio-fouling is the build up of bacteria on the well screen itself, reducing the area in the screen through which water can flow.

Maintenance of relief wells requires surging and pump testing of the well, and comparing the results to the test results recorded when the well was initially installed. Well testing and clearing should be accomplished by qualified well drillers. You can request technical assistance from the Corps on the proper procedures and/or a list of qualified well drilling contractors in your area.

#### **2.15 Seepage/ Sandboils (Levees and Floodwalls)**

Sandboils and seepage problems are not generally identified during routine inspections because these problems typically only appear under high water conditions. However, if sandboils or continuously saturated soils (not caused by ponded water or poor drainage) are observed on the landward side of the levee or floodwall under low water conditions, regardless of their size, they will likely become serious problems under high water conditions. Sandboils and underseepage is a serious problem that should not be taken lightly.



**Figure 2.41** Evidence of sandboils. (IN)

If sandboils are observed during a flood or low water conditions, or if there's evidence that foundation material is being (or has been) removed from the levee foundation, then the Corps should be contacted to evaluate the situation and provide technical advice regarding repairs. Appendix D of this manual provides additional information regarding seepage and sandboils.

## 2.16 Closure Structures (Levees and Floodwalls)

Closure structures must be in good repair. Placing equipment, stoplogs, sandbags, and other materials must be readily available at all times; stored nearby on the protected side of the levee, or stored on a trailer for quick transportation to the site. It's important that all components are clearly marked and that installation instructions and related procedures are readily available. You should regularly check your inventory of all components of the closure structure to ensure that stoplogs and other components will be there when you need them. Note that when aluminum stoplogs are stored, they should be supported along their entire length so they don't deform during extended periods of storage.



**Figure 2.42** *ACCEPTABLE* floodgate in a levee. (KS)

## 2.17 Concrete Surfaces (Applicable to all concrete structures)

Visible cracking, scaling, or spalling are signs of concrete movement and stresses within the concrete. Cracks in concrete walls that aren't repaired are subject to freeze / thaw damage, which widens the gap and leads to additional spalling of the concrete. When examining any concrete flood control structures, spalling, scaling, or cracking should be very minimal. Figures 2.43 through 2.47, on the following page, show various degrees of cracking, spalling, and scaling.





**Figure 2.43** *MINIMALLY ACCEPTABLE* 1/8<sup>th</sup> inch crack extends through concrete floodwall and needs to be sealed to prevent further damage. (MN)



**Figure 2.44** *MINIMALLY ACCEPTABLE* Vertical floodwall crack with spalling. The rating for this particular crack is Minimally Acceptable because the crack is still tight but there is some spalling occurring as well. (MN)



**Figure 2.45** *UNACCEPTABLE* exposed rebar. Monolith joint separation with exterior spalling along the joint and interior spalling in the area of the rebar. (MN)



**Figure 2.46** Detail of the crack in Figure 2.45, showing the exposed rebar that tied the two monoliths together. (MN)



**Figure 2.47** *MINIMALLY ACCEPTABLE* floodwall. Exposed surface rebar resulting from poor construction practices. The public sponsor has painted over the rebar in an attempt to keep it from rusting. (MN)

Fire and extreme heat can also be very damaging to concrete, and sponsors should discourage fires from being built beside concrete structures. Common grass or incidental fires are not typically a great concern, but repeated hot or large fires such as bon fires, camp fires, or brush fires can cause spalling in the concrete. Even though fire damage is not specifically listed in the Corps' FCW Inspection Guide (Appendix C), the related spalling, cracking, or other damage would be noted during an inspection and is something that should be taken seriously. If this type of damage is identified, efforts must be made immediately to stop fires near the FCW. Depending on the extent of the damage, the integrity of the structure should be investigated and repairs should be made as soon as possible.

Over time, concrete surfaces will weather, leaving the concrete rough to the touch, or will hold moisture on the surface. When this occurs consider applying a protective coating to the concrete to help prevent moisture from entering the structure. By applying a protective coating to the concrete surface and sealing the cracks the chances of freeze / thaw damage will be greatly reduced, increasing the life expectancy of the structure. Prior to the application of a concrete sealer the structure should be cleaned, existing cracks should be sealed with a flexible sealant, and any spalling repaired. Any sealer chosen for the concrete floodwall should be a water or solvent-based acrylic protective coating, which may be either clear or colored, and may be textured. A clear system should contain at least 23% solids by weight, and a colored system should contain at least 67% solids by weight and 46% solids by volume.

More serious damage such as spalling should be repaired as soon as it is identified, especially if steel reinforcing has been exposed. Perform concrete repairs with a polymer-modified Portland cement mortar that will provide a minimum of 2500-psi compressive strength in two hours. For repairs greater than 1 1/2 inches deep, add 3/8-inch clean-washed pea gravel so that aggregates don't result in variations of the physical properties of the mortar. Limestone gravel is not acceptable. All surfaces to be patched need to be structurally sound, clean, and free of loose debris, oils, vegetation, paints, sealants, and other contaminants. Remove all deteriorated concrete to a minimum of 1/4-inch in depth. Cut edges should be square with the concrete surfaces, and not feathered. Surfaces should be sufficiently rough to ensure a good bond. Any existing reinforcing bars should be thoroughly cleaned. If required, existing concrete should be removed to fully expose the reinforcing bar. Sandblasting may be required to clean them thoroughly. All surfaces should be fully saturated and freestanding excess water should be removed before applying the repair material. The material should be placed in the prepared area starting from one side and working to the other side. For vertical areas, trowel the material in an upward motion over the repaired area. Successive applications must be troweled against the previously placed material just prior to hardening. Work the material firmly into the bottom and sides of the repair. Level the material to the desired thickness and close up edges of the repair with a trowel. Finish the material to match the existing concrete finish. Remove any material applied or spilled beyond the desired areas. All exposed surfaces should be thoroughly saturated with water immediately after finishing.

## 2.18 Tilting, Sliding, and Settlement (Applicable to all Concrete Structures)

If soil conditions were poor prior to construction or if there has been inadequate soil compaction, concrete structures (floodwalls, pump stations, and gate wells) will frequently show signs of settlement. As the structure settles it may begin tilting in the lateral or transverse directions, settle vertically, or may even begin to slide downhill, if constructed on a slope. As the pressure within the concrete builds cracking and large spalls will develop. If the movement is considerable like that shown in Figures 2.48 and 2.49, a licensed engineer should be contacted to determine the best approach to correct the problem, or to closely monitor the structure during high water to avoid a structural failure.



**Figure 2.48** *MINIMALLY ACCEPTABLE* floodwall. Monolith joint separation caused by settlement, no landward or riverward tilting. The opening is about 3 inches wide at the top but the rubber joint sealer is still intact and undamaged. This joint has since been repaired by bolting another joint sealer on the both sides of the wall and filling the void with an expandable joint sealer. (ND)



**Figure 2.49** *UNACCEPTABLE* monolith movement in floodwall. The monolith shown in the photo has tilted about 6 inches riverward as well a vertically. Note the movement when compared to the adjoining monolith and the top cap. As the monolith moved considerable spalling has occurred along the joint. This project is monitored very closely during flood events. (ND)



**Figure 2.50** *ACCEPTABLE*. decorative floodwall is in straight alignment, with no tilting or spalling, and all joints are tight together. (MN)

## 2.19 Vegetation (Floodwall specific)

Vegetation must be removed from both sides of floodwalls for maintenance, flood fighting activities, and to protect the floodwall from damage from roots. Roots under a floodwall can greatly accelerate seepage rates during high water, increasing the chance of sandboils on the landward side and potentially leading to the failure of the structure. For these reasons, you should maintain a zone extending 2.5 meters (8') beyond both the underground toe and heel of the floodwall, keeping it free of everything but grass or sod, or possibly riprap on the riverward side. Since the floodwall may have been constructed in the shape of an inverted T, the underground toe and heel may extend several feet past the visible base. Additional guidance on landscaping around levees, floodwalls and embankment dams can be found in EM 1110-2-301, as referenced in Chapter 1.



**Figure 2.51 UNACCEPTABLE.** Trees growing too close to floodwall. (KY)



**Figure 2.52 UNACCEPTABLE.** Trees growing too close to floodwall. (KY)

## 2.20 Internal Drainage Systems

During non-flood conditions, rainwater is permitted to drain naturally through culverts in the levee and into the river. However, during high water, the gates on the drainage culverts are closed, and rainfall and flood seepage becomes trapped within the protected area of the FCW. If there is insufficient ponding area within the FCW, the water will need to be pumped over the levee or floodwall and into the river. Even if a levee operates exactly as intended to keep the river back, a community can still be flooded from within if the interior drainage system is not functioning properly.



**Figure 2.53 UNACCEPTABLE interior drainage** at the toe of an earthen levee. (OK)

Some of the features of an interior drainage system include ponding areas, drainage swales or ditches, inlet and outlet structures including gates and concrete components, culverts, gate wells, and pump stations. Natural or modified streams or ditches within the protected area are generally not considered part of the flood control project unless specifically stated in the project design. However, don't forget that you could still experience significant damage from seepage and rain runoff if these channels are not maintained.

As the public sponsor, it's your responsibility to ensure that all ditches, drainage structures, and other components of the project are kept in an acceptable condition. All drainage structures should be inspected and maintained at least once a year prior to flood season and again after periods of high water. The following paragraphs describe the maintenance of some components of interior drainage in greater detail.

**a. Drainage Ditches**

Drainage ditches should be maintained to ensure that the capacity of the ditch is not decreased by heavy vegetation growth or sedimentation. As part of a good maintenance program, the drainage ditches should be cleared at scheduled intervals and restored to the original channel design grade and cross section. Material removed from drainage ditches should be removed from the floodway, and not left in area near the banks. Removal of the excavation spoils will improve water quality and help to prevent further flooding and maintenance problems. During an inspection, drainage ditches are rated on flow capacity, sedimentation, vegetative growth, and cross section. Regularly scheduled maintenance will ensure the flood control project performs in a satisfactory manner during high water.



**Figure 2.54** *ACCEPTABLE interior drainage channel. (IA)*



**Figure 2.55** *MINIMALLY ACCEPTABLE vegetation (cat tails and bull rushes) in interior drainage ditch. (MN)*



**Figure 2.56** *UNACCEPTABLE vegetation and sediment in interior drainage channel. (IA)*



**Figure 2.57** *ACCEPTABLE interior ponding area and drainage ditch. (MN)*

**b. Concrete Culverts/ Pipes**

All culverts must be clear of debris and must be structurally sound. Remember that inspections of drainage structures require compliance with confined space entry regulations. Any spalling in concrete culverts should be patched with an appropriate concrete material as described above. Repairs should be made to the bottom of the culvert if they show more than 1 inch of loss due to wear and abrasion. If significant settlement is detected in a culvert or pipe, it should be excavated, the foundation raised, the pipe replaced, the fill material added in four inch layers and compacted around the pipe to a density equal to or greater to that of the surrounding undisturbed material, and the area reseeded. Do not use a roller or heavy machinery to compact fill material when repairing the settlement over a culvert.



**Figure 2.58** Concrete drainage tunnel. (AK)



**Figure 2.59** The culvert on the left is Minimally Acceptable with sediment accumulation within the culvert. The culvert on the right is totally unacceptable with 2/3 of its flow capacity reduced by sediment and debris. This project was rated as UNACCEPTABLE because of the reduced flow capacity of the culverts. (MN)



**Figure 2.60** MINIMALLY ACCEPTABLE, vegetation blocking the concrete culvert must be removed. (KS)

### c. Corrugated Metal Pipes

One significant maintenance item in many levee systems involves the repair and replacement of corrugated metal pipes (CMPs). Many levees all over the country were constructed with corrugated metal pipes to transport interior drainage, because CMP was one of the cheapest and most reliable materials available at the time. When the levees were constructed, the engineers designed them for an established design life (usually no more than 50 years), and since CMP was predicted to last for design life of the project, it was the material of choice for many drainage culverts. However, with many of the levees around the country at or beyond the design life of the CMP, it becomes critical that the pipes are inspected frequently and thoroughly, and replaced as needed. Remember that even if a CMP looks OK on the inside, the outside of the pipe may be very corroded and weak. Interior and exterior rust, reduction in metal thickness, joint separation, holes, and settlement, have all lead to the failure of the culverts. When a CMP fails during a flood, not only does the culvert cease to function as necessary, but material from the levee collapses to fill in the void, leaving a low spot in the crown of the levee. This low spot can quickly lead to a breach in the levee and the flooding of the protected area.

In some cases, a decaying CMP may temporarily be maintained by lining the pipe with an appropriate plastic liner or by patching it in various ways, but these are only temporary solutions and the pipe will eventually need to be replaced as part of the ongoing maintenance of the project. Because of this, you need to budget for the replacement of the pipes as their design life comes to an end. If it is noted during an inspection that a CMP culvert is Minimally Acceptable and the levee becomes damaged during a flood as a direct result of the failure of the CMP, then the Corps will deny post flood rehabilitation assistance for the repair of this damage. The maintenance and replacement of these pipes is considered to be part of the ongoing maintenance of the project and is therefore the responsibility of the public sponsor.



**Figure 2.61** UNACCEPTABLE, Failing corrugated metal pipe. DO NOT WALK INTO A FAILING CULVERT LIKE THIS. This section has actually separated, allowing the surrounding soil to enter the pipe and the overburden to collapse. This sponsor was denied rehabilitation assistance due to this maintenance deficiency.



**Figure 2.62** Pieces of the same pipe, once removed from the levee. Note that while much of the pipe may have appeared to be in good condition from the inside, the outside was extremely corroded. The public sponsor attempted to patch the pipe the first year, but when it failed again, the entire CMP was replaced.

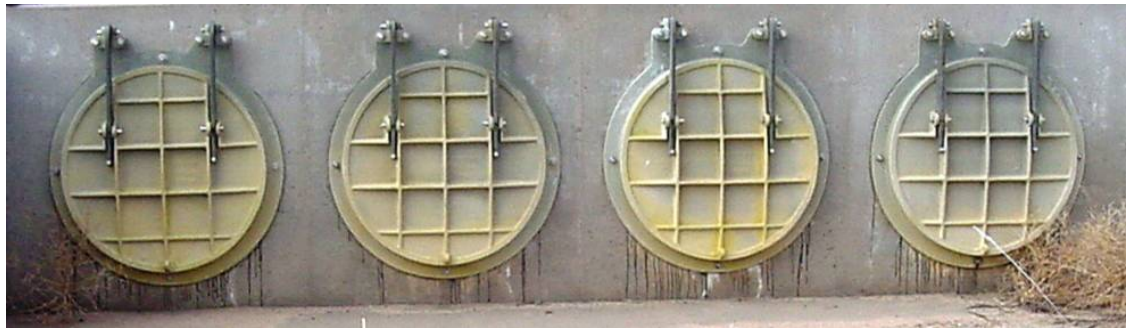
#### d. Gated Structures

All flap gates, slide gates, and other gate systems need to be inspected and lubricated at least once a year just before the flood season. If gates aren't seated properly, water will flow back through the drainage structure during high water. During the inspection, all gates should be manually operated, and any debris or obstructions removed. All gate seats should be checked and the

frames readjusted if the gate is not seating properly. Cracked or damaged gates need to be replaced. The inlet and outlet channels need to be kept free of debris, trees, brush and other vegetation, and sediment. All concrete cracks in the inlet/ outlet structure need to be repaired. Metal grates, hand wheels, and other metalwork should be secure and sound, free from rust, and regularly maintained by cleaning, painting, and greasing. If any pipe or culvert has separated from the inlet/ outlet structure headwall, this needs to be repaired as soon as possible. When high water is predicted, all flap and slide gates should again be inspected and any debris or obstructions should be removed immediately.



**Figure 2.63** ACCEPTABLE culvert gate. (LA)



**Figure 2.64** ACCEPTABLE flap gates in earthen levee. (KS)



**Figure 2.65** UNACCEPTABLE vegetation around flap gates in earthen levee. (OK)



**Figure 2.66** UNACCEPTABLE flap gate in earthen levee. (Broken hinge and vegetation growth.) (MO)



## 2.21 Pump Stations

Pump Stations should be inspected at least annually by the sponsor, preferably just before the flood season, following the manufacturers' publications and recommendations on maintenance. Preventative maintenance includes adjusting, lubricating, repairing, and replacing worn out or defective parts. A guide for the inspection frequencies and tasks for the various items of equipment is usually found in the manufacturer's recommendations, but may need to be adjusted depending on the frequency of operation of the pumping station. Any change to the manufacturer's recommendations should be coordinated with the manufacturer to avoid the possibility of voiding warranties.



**Figure 2.67** Hole in roof of pumping station. (IL)

Some pump stations are located in remote areas and operated automatically. These stations may be easily overlooked, but need to be inspected, tested, and maintained just like any other pump station.

Megger tests need to be conducted at least every other year to ensure proper insulation of electrical components. While the cost of running the pumps typically prohibits the Corps from conducting a Megger test during continuing eligibility inspections, you need to conduct this test on your own when the pump is in operation. A logbook needs to be maintained at each pump station, which should include the date and type of testing conducted, the maintenance performed, and the number of hours each pump or piece of machinery was operated.



**Figure 2.68** Pump station beside earthen levee. (OK)

Pump stations are exposed to potential fires, and should have adequate fire protection measures. This would include safety equipment for diesel generators and may include automatic sprinklers.

## 2.22 Flood Control Rivers and Channels

Flood control channels should be inspected on a regular and continual basis to ensure that erosion is not causing bank instability that could result in a bank failure/ sloughing. When areas of bank instability or erosion are located, measures should be taken to correct the problem. If left unattended, the continued bank erosion will form sediment shoals within the river channel causing a reduction in channel capacity. As the shoals grow in size they begin to support vegetation and divert the channel flow into the river bank, causing additional bank erosion and instability. Trees that have fallen into the river channel or that may soon fall need to be removed to prevent log jams during high water, which can cause significant damage as described in section 2.5 above.



**Figure 2.69** *UNACCEPTABLE* vegetation in channel and sediment shoaling. (OK)

Sedimentation, silt, vegetation, downed trees, and other debris in the channel must be removed to maintain channel capacity. These materials should be disposed of in a manner that does not adversely affect the project or the floodway/floodplain. This improves water quality as well as helping prevent further flooding and maintenance problems. Before removing any sediment, trees, vegetation, or placing rock bank protections, you should contact the Corps' Regulatory Office and your local Department of Natural Resources to determine if any environmental permits are required.



**Figure 2.70** *UNACCEPTABLE* channel shoaling below a control structure. The original channel bottom extended all the way to the riprapped banks. There is an estimated 2-3 feet of sediment in the channel, mostly from upstream field erosion and highway construction. (MN)



**Figure 2.71** *MINIMALLY ACCEPTABLE* shoaling within a concrete lined channel. (MN)

### 2.23 Concrete Lined Channels

Concrete lined channels should be kept clear of debris, sediment, and vegetation. The concrete, flap gates, and other structures must be inspected annually and maintained as described in previous sections of this chapter. Sample maintenance and inspection activities may include (but are not limited to) clearing the sediment, vegetation, and debris; replacing joint seals as needed, and repairing damage to the concrete.



**Figure 2.72** ACCEPTABLE concrete lined flood control channel. (ID)



**Figure 2.73** ACCEPTABLE intake structure upstream of the concrete channel. (ID)



**Figure 2.74** ACCEPTABLE concrete lined channel. (AK)



**Figure 2.75** UNACCEPTABLE vegetation and extensive sediment in channel. (TX)

### 2.24 Debris Basins

Debris basins, sometimes called sediment retention basins, are reservoirs that are placed upstream of flood protection or navigation channels in order to collect sand, rocks, logs and other debris, and prevent it from obstructing the channel downstream. They help with flooding and navigation, and make the project easier to maintain, since it's easier to clean out the basin than to remove debris from the entire length of a channel.

As the basin fills up with sediment, the flowing water tends to take on the same width as the natural channel (rather than spreading over the surface of the basin), and the basin loses its ability to hold back as much debris. For this reason, debris basins are designed with the intent that they'll be periodically cleaned out. While some basins may have a 50 or 100-year capacity, others are sized for only one or two major storms.

Remove the sediment from the debris basin whenever it approaches one-half of its capacity by visual inspection, and whenever the deposits direct the flow against the channel or levee slope where they can cause erosion. Remove any large obstructions after every high-water event. The debris basin should kept be free from brush and trees, and sod should be maintained over the area to protect it from erosion.

The bottom of the basin slopes can erode during high water. Any eroded areas should be repaired as described in previous sections of this manual, and riprap or other erosion protection should be placed along the slopes to prevent further damage.

## **2.25 Floodways**

A floodway is a designated piece of land that is purposefully left clear of development, for the purpose of passing floodwaters. When water rises beyond the capacity of the nearby rivers and channels, it then passes over this designated area. (In some areas of the country, the term floodway is used to designate the 100-year floodplain.) Floodways must be maintained so that when water passes over them, it doesn't rise beyond the expected levels. Obstructions such as earth deposits, debris, trash, undesirable vegetation, or unauthorized structures or encroachments reduce the floodway capacity and must be removed and disposed of properly. Vegetative growth that contributes to the preservation of natural resources and wildlife should be left alone unless the growth lessens the degree of protection or threatens the structural integrity of the project.

### 3. FLOOD PREPAREDNESS



**Figure 3.1** Flooding along Skagit River. (WA)

Flood fighting is an art, and can be extremely difficult to execute. There is no absolute method that one can apply to guarantee success. However, failure to react in a timely manner and apply proven flood fighting techniques greatly increases the risk of failure. Although each flood is unique, there are many common elements from one flood to the next, and plans and preparations will improve your response time and success.

Public sponsors of flood control works are responsible for project maintenance and flood fighting activities during high water events. To be ready for these tasks, sponsors are responsible for establishing flood fight plans, conducting training, stockpiling needed materials, and for other

flood preparations. Disaster preparedness and flood fighting training are necessary for project inclusion in the U.S. Army Corps of Engineer's Rehabilitation and Inspection Program (RIP). This chapter outlines some basic preparedness activities that will help insure that your flood responses will be timely and effective.

#### 3.1 Flood Fight Equipment and Supplies

As the local project sponsor, it is your responsibility to stockpile and maintain the necessary supplies and equipment needed to respond to typical high-water events. In a flood, the stockpiled materials will allow you to quickly provide an initial flood response while additional materials and equipment are being delivered. The specific requirement for supplies varies depending on the size of your FCW and on past flood events. The best way to determine the quantities that are needed is to look at the supplies that were needed during previous floods. For example, if you typically use 1,500 sandbags in a flood response, then you should maintain a stockpile of 1,500 sandbags in a secure location within the protected area.



**Figure 3.2** Sandbag storage in a levee pumping station. (OK)

**a. Sandbags**

As stated above, it's your responsibility to maintain an adequate supply of sandbags to allow you to respond to typical high-water events. Burlap sandbags have a limited shelf life (usually about 8 years if humidity is controlled) and should be inspected annually and replaced when necessary. The stockpile of sandbags should be stored in a dry, secure location that does not expose the sandbags to sunlight. Continued sunlight and weather will rapidly deteriorate the sandbag material.

**b. Plastic Sheeting**

There are many applications for plastic sheeting during flood fights. If it is one of the things that typically gets used in your community during a flood fight and there is any doubt about its availability during an emergency, it should be stockpiled in preparation of an event. 6 mil polyethylene sheeting is the minimum thickness recommended for flood fighting applications.

**c. Shovels/ Sandbag Filling Machines**

If you've identified places that you know you're going to need a lot of sandbags, then you need to have a reliable method for filling them, and you may want to consider investing in some equipment that will let you do it more quickly. Some Corps districts own sandbag filling machines and can lend them out during emergencies. If these machines are needed, you should contact your State. Since the availability of these machines changes, your State may need to coordinate and prioritize these requests before passing them to the Corps. See Appendix D for details on sandbagging operations and other tools that have been used.

**d. Emergency Lighting**

Unfortunately, flood fight operations don't stop at night. It is strongly recommended that you plan ahead to find some emergency lighting which would be readily available for use during flood fights.

**e. Communications System**

A reliable communication system is extremely important for coordinating flood fighting efforts and for calling for assistance when needed. Cell phones work very well but are limited in their capacity for communicating with multiple people at one time, which can be important during emergencies. You may also experience dead spots or non-availability of service if the phone traffic is very heavy. Because of these problems, two-way radios are preferable because they are extremely reliable for short distances and have the capability to broadcast to several people at once. Without a reliable communication system, any flood fighting effort will be much more difficult and will probably require additional man power.

**f. Riprap for Erosion**

It is recommended that you develop plans to address erosion that may occur during a flood emergency. It might not always be necessary to stockpile riprap, but you should at least know the location and emergency telephone numbers of local quarries capable of supplying riprap if it's needed. Some levee districts choose to keep a supply of gravel on hand, so they can maintain the levee access routes during an emergency.

**g. Floatation Vests.**

The safety of workers and volunteers should always be the highest priority during a flood fight. Floatation coats or vests (PFD) are recommended and should be worn at all times when working near the riverward crest of the levee, on the riverward side slope, or near fast moving water. Floodwaters can quickly sweep a person downstream, and hypothermia can set in quickly in cold water conditions.

**h. Pumps**

Like sandbags, pumps are also a critical part of any flood fighting effort. Pumps are used to control interior drainage and seepage through the levee. Those communities that experience frequent flooding should consider purchasing one or more high capacity pumps. If additional pumps are needed during a flood fight, you should contact your State, because your local Corps district office may have pumps available, but your State may need to coordinate and prioritize these requests before passing them to the Corps.



**Figure 3.3** *Portable pumps supplied by the Corps of Engineers during an emergency.*

**i. Sources of Borrow Material**

Sources of borrow material should be located prior to a flood event. Several borrow areas should be identified in advance, because wet or sloppy weather could unexpectedly limit access to some sites. Carefully consider the access points to your levee when you choose the sites for the borrow material.

### **3.2 Plans**

It is a local sponsor's responsibility to develop and maintain a minimal level of written plans, and to keep those plans up to date. The extent of the plans depends on the specific FCW. Large systems with multiple pumps and drains would require more detailed plans than smaller systems. Documented plans ensure that the information needed to address known problem areas will be available during a flood, even if the main supervisor is unavailable. As a minimum, every sponsor should maintain at least an organizational chart or roster, and lists or maps of important project features. Additional planning is also recommended, and some guidance is presented to help you develop these plans.

As you read through this section, you'll see that there's a large amount of planning that can be done in advance of a flood. While it would clearly take a substantial amount of time to collect and update all of the information described, don't be discouraged and assume that this planning is too big of a chore to ever begin. Instead, try to prioritize the work, remembering that every piece of information you assemble and every decision you can make before an actual flood will potentially make your response that much more effective during a real emergency.

#### **a. Organizational Chart / Roster**

You need to keep an updated list of project supervisors, inspectors, and other personnel, including their detailed contact information. The list should clearly indicate which people would be contacted during a flood emergency.

Additionally, it's strongly recommended that you compile a directory including telephone numbers for your Corps district's Emergency Operation Center, local contractors, flood fight supply and equipment vendors, the Red Cross, Salvation Army, hospitals, railroad/ highway departments, the police and fire departments, local and state Emergency Operations Centers, and other critical numbers.

#### **b. List of Important Project Features**

As a minimum requirement for planning, you need to develop and maintain either a bullet-point list or annotated map that describes each project feature and areas of concern during a flood event. The list should clearly note things such as:

- Low areas
- Areas subject to boils
- Areas of known seepage
- Areas of recent rodent activity
- Alternate access points to the levee (should one become impassible)
- Locations of drains that should be checked for closure
- Available sources and locations of sandbags, pumps and other supplies



Along with this information, you should develop and maintain a detailed table of all of the locations of project features that may need to be closed, such as

- Floodgates
- Flap gates
- Other closures

In this table, you should indicate the river level or other indicator that would signal that each of these project features needs to be closed. Remember that the highway or railroad departments need to be contacted prior to closing roads or railroad tracks running through levees and floodwalls.

**c. Flood Response Plan**

It is strongly recommended that you supplement the previously mentioned rosters and lists of project features with a site specific flood response plan. This plan does not have to be long and shouldn't be wordy, but should outline the things that need to be done during a flood fight, and indicate when they need to be done. Ideally, it would also delegate responsibilities for the tasks, and this information would be updated as necessary to account for changes in personnel. Your plan should identify necessary information such as potential assembly or staging areas for flood fights, and the location of earth borrow sites, and should address procedures for maintaining records of equipment, manpower, and supplies used during a flood fight. The records are key items for obtaining assistance for flood and post flood activities. Flood fighting plans should acknowledge that it may not be feasible to protect entire communities, based on economic or time and equipment considerations; therefore, evacuation of certain areas may be a necessary fact of an emergency operation. There should be a plan of evacuation for all areas lying in the flood plain, in case the need develops. See the following chapter of this manual for additional information on flood response plans.

**d. Short Term Planning Elements**

In addition to your long-term planning, it is your responsibility to have an understanding of the FCW and the ability to address any short term situations that may arise during the life of the project. For example, if a culvert that runs through a levee is being replaced, then you need a plan for what to do in case there's a flood during the construction, when the levee integrity is lacking.

**e. Continued Plan Management**

Your flood response plan should be reviewed annually and after each event where flood levels reach half of the levee or wall height, or where an unusual or unexpected incident has occurred.

Annual plan updates should include verification that sources of emergency equipment, contact names and telephone numbers are current, review of evacuation routes and emergency shelter locations.

After a flood or flood exercise, closely examine the events and actions taken to determine whether they were effective and efficient. Because floods may occur decades apart, it's important that information be recorded for use in future planning efforts. Debriefing sessions, with all participants represented, provide valuable feedback on the lessons learned. Note which actions worked well, and identify the reason for their success. Note which actions could be improved upon, and solicit suggestions to correct the problems. Collect data on the response effort, such as necessary materials, equipment, man-hour estimates, weather reports, and monitoring reports. Compare the planned responses with the actions taken, and incorporate the information learned into the plan.

Updated information should be forwarded to the Corps and to your local and state Emergency Operations Center.

### **3.3 Training and Exercises.**

As the public sponsor, you are responsible for training personnel to operate, maintain, and patrol your FCW. The Corps encourages you to hold training or flood control exercises at least once a year. There are many reasons to hold these exercises. First, they show new personnel how to do things like operate the closure structures, respond to sandboils and patrol the FCW during a flood. Second, none of the plans you've developed for a flood response are any good unless they're practiced and communicated to those who need them. Training exercises also let you know how much time and manpower is necessary to complete certain tasks. Important practical considerations and physical limitations that could be easily overlooked in a plan become clearly exposed during an actual exercise.

At a minimum, these exercises should include:

- Physical operation of project features such as sluice gates, pumping stations, and closure structures
- Notification of emergency response personnel
- Testing communications/ backup communications system
- Mobilization of monitoring teams, and monitoring project features
- Basic flood fight techniques, such as how to ring a sandboil
- Coordination and control (between volunteers, patrols, operators, nearby levee districts, the highway department, the state Emergency Operations Center, the Corps, etc.)
- Dissemination of information to the public

The exercises can also be more elaborate, to include other emergencies that may take place during a flood such as car accidents or gas spills occurring when interior streets are flooded or evacuation routes are flooded. The exercises should be tailored to your community. Representatives from agencies or organizations that would actually be called upon, such as medical personnel, public works, and the mayor's office might be involved in planning more complex exercises. You are encouraged to involve the local and state Emergency Operations Center in these events, and your local Corps district can also provide technical assistance for training and exercises as needed.

Documentation of the exercise is important to identify where any shortfalls exist in planning and coordination, training, personnel, equipment, and facilities. Debriefing sessions held with all participants can provide valuable feedback on the effectiveness of policies and procedures, identification of areas of improvement and suggestions to correct deficiencies. Lessons learned during the exercise should be incorporated into the project operations plan and local emergency operations plan.

### **3.4 Relations with Local and State Partners**

There are usually many ways that your county and state can assist you during a flood. For example, states may provide trucks, tractors, radios, helicopters for emergency inspections, support from the National Guard, or financial assistance. If you run out of supplies needed for a flood fight, you should try to find the needed supplies at the local and state level, before requesting this aid from the federal government. The Corps expects counties and states to be involved with the levee districts, and provides support only when state resources are being fully utilized. For these reasons, you are strongly encouraged to maintain relations with the Emergency Managers at your local and state Emergency Operations Center and to contact them at least once annually, well in advance of a flood. You should keep them informed on the condition of your project, and send them ongoing situation reports during a flood response. It's very important that you know what kinds of support the state can provide, and that you know who to call in order to get the support you need.

This page intentionally left blank.

## **4. ACTIONS DURING HIGH WATER EVENTS**

This chapter provides sample framework that you could use as a starting point as you develop your community's flood response plan, as described in Chapter 3. The chapter outlines many of the steps that are recommended immediately before, during, and after high water events. Not everything that's included here will be applicable in all situations, and there's a lot of important information you may find necessary to add. Building on the material presented, a flood response plan should be developed that would identify and prioritize the given activities, identify locations along your FCW which would require attention, go into more specific details as to how the tasks should be completed, and specify who within your community would be responsible for them. Additional details on some of the steps listed (for example, how to raise a levee) are presented in Appendix D.

The response activities listed below have been broken up into two phases. Phase I activities include the preliminary response activities that should be completed before the river rises to its bank full stage. By the time the river reaches its bank full stage, everything should be ready, and all necessary personnel should be prepared to respond to the flood. Phase II activities include the things that should take place once the river has risen to some gage-height beyond bank full, which is something should be decided ahead of time. With some rivers, it's possible to specify a river gage level that would indicate when the activities should expand from Phase I to Phase II. Other rivers rise more quickly, and the expansion of response activities depends more on the developing situation than on a predetermined gage height. In developing your flood response plan, consider the characteristics of all adjacent rivers and streams. Flashing streams and rivers require rapid response, while moderately rising streams or rivers allow greater reaction and warning time. It's essential that your flood fighting activities are based on the available time.

### **4.1 Phase I: Preliminary Response Activities**

#### **a. Public Sponsor Duties**

Upon receipt of official information forecasting imminent high water, the levee district should immediately alert all project personnel concerned in flood fighting operations, mobilizing a skeleton organization capable of quick expansion. If the public sponsor is responsible for many miles of a levee system, definite sections of the levee should be assigned to individual section leaders/ supervisors. Additionally during Phase I, the sponsor should:

- i. Review emergency plans and past lessons learned; identify problem areas.
- ii. Verify that personnel have access to the gate keys, current rosters, a listing of project features and closings, plans, and other critical items.
- iii. Coordinate efforts with communities upstream and downstream of you.
- iv. There may be isolated gates or valves on private property, and the owners may need to be alerted to take action.

- v. Alert the community to the potential of flooding. This will give them advance warning to take action to minimize potential damage to their business or home.
- vi. Keep local/state Emergency Operations Center informed of the situation.
- vii. Begin documenting the situation; send situation reports to the local or state EOC and to the Army Corps of Engineers as necessary. (It's not necessary to send reports to the Corps every time there's high water; only during unusual situations or when there's the potential for significant damage or overtopping.)

**b. Initial Project Inspection**

As soon as they've been notified that high water is expected, section leaders/ superiors should immediately make a thorough inspection of their section of the levee, omitting nothing from this inspection based on adequate performance during past high water events. In addition to the items that are typically inspected during patrols (which are listed in part c, below), special attention needs to be given to the following items during this initial inspection. (Note that several of these items can and should be accomplished annually and not wait for a high water prediction.)

- i. Section Limits: Ensure that the dividing line between sections/section leaders are clearly defined and marked, if necessary.
- ii. Condition of any recent repairs to the levee.
- iii. Water conditions and any accumulation of trash, debris, ice, etc.
- iv. Transportation Facilities: roads, rail, and water access.
- v. Material Supply: Identify location, quantity, and conditions of all necessary tools and materials (sacks, sandbags, lumber, lights, etc.) and distribute and store them at points where maintenance is anticipated.
- vi. Communications: Locate and check all two-way radios and telephones.
- vii. Drainage Structures: Most drainage structures are situated to convey interior drainage from low points of the protected area through the levee by gravity flow. Because of the location, drainage structures are generally subject to inundation at lower stages than most other project features, and special attention needs to be given to flap gates and other drainage structures that might not be accessible later. (See section d, below, for maintenance during high water.)

**c. Patrols**

To minimize damage and to prevent the FCW from failing, any problems must be detected early and treated appropriately. The entire FCW should be patrolled at least once a day during the Phase I response and continually during Phase II. Patrols should be conducted by teams, rather than by individuals. Many of the tasks typically accomplished during high water inspections and patrols are listed below. Any significant or unusual conditions identified should be reported to the Army Corps of Engineers. The following section lists some typical responsibilities of patrols.

## **i. Patrol Responsibilities:**

### **General items**

- Record gage readings. (hourly)
- Inspect fences on the riverside of the levee frequently to make sure they are free from debris. If debris does collect along the fence, it must be cleared immediately or the fence must be cut to free the debris and decrease the possibility of damage to the levee.
- Verify that all necessary access roads and ramps along the levee are usable or will be satisfactorily conditioned.
- Take photographs of all significant issues. (Use date/time stamp on your camera when possible)

### **Levees**

- Look for sandboils or unusual wet areas landward of the landside toe.
- Look for slides or soughs in levee side slopes.
- Look for wave wash or scouring of the riverside levee slope.
- Look for low areas in levee crown.
- Monitor relief wells (flowing/non-flowing).
- Check flap/sluiice gates for proper closure.
- Check gap closures (stoplog/ sandbag, etc.).

### **Floodwalls**

- Look for saturated areas or sandboils landward of the floodwall.
- Look for settlement (movement) of the floodwall.
- Look for bank caving which may affect the structural stability of the floodwall.
- Inspect toe drain risers (discharging/non-discharging).
- Inspect the landside of floodwall for any leakage, especially around the monolith joints.
- Inspect for wet areas, soft areas, seeps, and sink holes landward of the toe of the floodwall.
- Check gap closures (stoplog/ sandbag, etc.).

### **Pump Stations**

- Verify proper ventilation (fans on, vents open, etc.) of the pumping plant, to prevent overheating of pump motors.
- Look for sink holes or wet areas around the perimeter of the pumping plant, and/or settlement of the pump house, all of which could potentially be the result of separation in the conduits. If this condition is suspected, the pumps and motors should be shut down until an engineering review can be conducted to analyze the condition.
- Verify that assigned operators are on duty 24 hours daily.

## **ii. Equipment for Patrols**

- Portable radio or cell phone
- Watch
- Log book
- Patrolling instructions
- Plan of action for patrolling
- Plans of flood control project
- Operation and Maintenance Manual for the project
- Weather gear
- Flashlights
- Record Log
- Life Jackets
- Probing rod
- Short wooden stakes
- 40 feet of ½ inch nylon safety line to connect team members
- Camera

## **iii. Safety/Security Precautions**

The members of the patrol team should walk side by side with one person on the water side of the levee near the water surface, one at the top of the levee, and one on the land side toe of the levee. The team should move slowly enough to enable the member closest to the water to probe below the surface with a rod, to discover any erosion that may be taking place. The person closest to the water should be wearing a safety line.

The person walking closest to the water should be especially observant of floating objects. The limbs and roots of a floating tree that has been uprooted can extend above the water surface and strike anyone walking along the water's edge. To increase the chance of seeing floating objects, it's best to walk upstream when patrolling the water side of the levee.

When patrolling floodwalls, the patrol should not attempt to walk the top of the wall, but should concentrate on potential problem areas on the land side (inside) of the wall. Where the wall is more than five feet above the land side ground level, it is recommended that observation points be selected every 100 yards or so, and ladders used to observe the water side of the floodwall.

Each person on the patrol should be thoroughly familiar with the community evacuation plan and signals. If evacuation is necessary, the patrolling organization should move to a predetermined location and keep the team intact.

If evacuated, when returning to the levees and floodwalls, physical conditions may be considerably different from those observed prior to the evacuation, especially if



the levee was overtopped. If overtopping occurs during the darkness, it's recommended that the patrols not be resumed until daylight, though there may be cases where this recommendation can't be followed.

Patrols should also keep an eye out for anyone that seems out of place, or who is doing something that looks doubtful. There are unfortunately some people, terrorists or otherwise, that would try to take advantage the already dangerous situations on levees or floodwalls for their own purposes. Any suspicious activities observed by the patrol should be reported immediately to the local law enforcement agency.

#### **iv. Interaction with the public**

The patrol team may see observers on the levees or at floodwalls. If there are many observers, it is recommended that an additional person be assigned to each patrol team. This additional person will act as a safety officer, explaining the dangers that are present. The patrol team is not responsible to order observers off the levees and floodwalls.

It is recommended that each team carry and pass out instruction cards describing the community evacuation plan. It is important to pass out information, so the observers are aware of the danger.

#### **d. Phase 1 General Maintenance Activities**

Once the initial inspection has been completed, each section leader should organize his labor force to take care of any pressing maintenance issues, before the river rises further. Emergency maintenance activities are no substitute for normal annual maintenance, and many of the activities listed here should not wait until high water.

- i. Because of their location, drainage structures are generally subject to inundation at lower stages than most other features of the flood control project, and any maintenance problems need to be identified and corrected as quickly as possible before the water rises. Manually check all flap gates that are critical or in questionable repair, and maintain as needed. Sluice gates should be inspected before the outlet end of the structure becomes submerged, and any trash, debris, or other potential obstruction present should be removed. If, for any reason, the gate system on a drainage structure fails to operate and cannot be repaired because of high water, immediate consideration should be given to blocking the structure opening by other means. If stream stages permit, the outlet end of the structure should be blocked using timber, metal plates, tarps, sandbags, or by other means. If the efforts to plug the outlet structure fail, immediate action should be taken to build a sandbag or earth ring around the inlet structure. While the primary concern in blocking the structures is to prevent high stages of the river from

flowing into the protected area, emergency closures should be such that they can be readily removed after the river recedes.

- ii. Immediate attention should be given to the grade line of each levee section or profile by comparison of existing grades with those shown in “As Built” record drawings. Fill any holes, gullies, and washes in the levee crown, embankments, and landside berms with compacted fill material if possible, or otherwise fill them with sandbags. (See Appendix D for details)
- iii. Examine all drainage ditches on the landside of the levee and remove any obstructions. Be prepared to construct seepage drainage ditches, but not until actual seepage appears. Excavation of ditches near the levee or in the long berm area is hazardous and should not be undertaken except under direct supervision of the section leader and with the advice of the Corps of Engineer advisor assigned to that unit.
- iv. Repair all levee settlement or depressions which have been worn down below levee grade. Materials to be used in filling holes and depressions should be obtained from distant sources (not adjacent to a levee system) unless it has been determined that borrowing in areas adjacent to the levee will not adversely affect its stability or the control of underseepage. Avoid taking material for these repairs from the area adjacent to the levee, particularly in the area of the seepage berm, except under direct supervision of the section leader and with the advice of the Corps of Engineer advisor. The fill material should be compacted and protected from wave wash and other erosion as necessary.

**e. Other Phase 1 Activities**

Once the initial inspection has been completed, each section leader should organize his labor force to perform the maintenance work as described in Appendix D of this manual. Additional activities to complete during Phase I are listed below:

- i. Review assignments for patrols, closings, etc.
- ii. Obtain lists of all construction equipment, motorboats, cars, earthmoving equipment and trucks that can be made available.
- iii. Assess needed support (Vehicles, radios, etc).
- iv. Verify serviceability of flood fighting equipment.
- v. Record gage readings and monitor river stages.
- vi. Close the levee to the public and remove cattle as necessary.
- vii. Install levee or floodwall closures as necessary. (Remember to coordinate all road closings with the Department of Transportation or railroad authorities before limiting road or rail access through the levee!)
- viii. Remove all dynamite and explosives from the vicinity of the levee.

## 4.2 Phase II: Full Response Activities

### a. Continuing Activities

- i. Patrol continuously, 24/7 (as the situation requires).
- ii. Be sure all of the closures and gates are in place, and all maintenance is complete as described in Phase I, above.
- iii. Completely remove padlocks from access gates to facilitate patrols.
- iv. Monitor inventory of flood fighting equipment, materials and supplies as they are used.
- v. Keep the public informed of the current situation through the media, if warranted.
- vi. Repair any erosion and seepage problems identified by patrols as quickly as possible, as described in Appendix D of this manual.
- vii. During flood periods, competent operators should be on duty whenever it appears that operation is imminent, even when station operation has been automated. Operators should thoroughly understand the manner in which the pumping station was designed to operate and be capable of manual operation should automated equipment or sensors fail.
- viii. Portable pumps may be used to pump water over the levee, if water is ponding in undesirable areas or is rising too quickly in ponding areas. Ponding areas should be continually patrolled during high water.
- ix. Monitor debris basins and trashracks for sediment and accumulated debris. As debris and sediment continue to be deposited in the basin, debris loads will substantially block racks, and sediment deposits will block the entrance to the basin, forcing the flow against the sides. Any large accumulation of debris on racks or flow directed on the sides of basins will cause local erosion and scour. Levees and concrete structures that are part of the debris basin facility will need to be closely monitored to ensure performance. Debris should be removed from trashracks at pumping stations periodically when the station is in operation.

### b. Volunteer Assistance

If it becomes necessary to recruit volunteers during the flood fight, there are a number of steps that can be taken to organize their support.

- i. Identify primary and alternate assembly areas, with adequate parking.
- ii. Arrange transportation, subsistence, and shelter for the labor force as appropriate.
- iii. Contact media to request that volunteers report to the designated assembly area, bringing flashlight, work gloves, rain gear, shovel, and a snack.
- iv. Maintain sign-in roster at assembly area, to account for volunteers and personnel (name, home phone number, address, work group assignment).

- v. Identify staging areas, away from the work site but as close to the flood fight locations as possible and with good access to clear roads. Separate areas in the staging site should be established for:
  - sandbag filling
  - carrying and loading
  - materials stockpiles
  - rest and breaks
  - first aid
  
- vi. Establish an emergency operations center to oversee the flood fight operations, and for interagency coordination. This operations center is to be manned 24 hours daily until the emergency is over. Consider equipping the EOC with:
  - Radios and telephones for communication
  - Television and/or radio to monitor weather and river forecasts
  - Emergency generator in case of power outages
  - Flashlights
  - Administrative supplies
  - Levee operations and maintenance manuals
  - All emergency action plans
  - Past flood reports/ after action reports
  - State, county, and local maps; utility, flood plain, and levee maps
  - Telephone books, phone rosters, and a directory listing numbers for the Army Corps of Engineers' Emergency Operation Center, railroad/ highway departments (needed when closing access), local contractors, the Red Cross, Salvation Army, hospitals, the police and fire departments, local and state Emergency Operations Centers, and other critical numbers
  
- vii. Establish traffic patterns that will be used to move the sandbags from the staging area to the work site. If conditions permit, one-way traffic patterns should be established on the levee system if trucks are going to be used to transport the filled sandbags to the laying party.
- viii. Be certain that the people laying sandbags are well supervised by a trained individual that knows how to properly lay the sandbags.

### **4.3 Evacuation Plans**

You should be ready with a plan to evacuate the area. Consider the following points:

- a. Immediately coordinate evacuation with police, fire department, and responders.
- b. Remove sign-in roster and contact information from EOC, if possible.
- c. Follow the predetermined plan for evacuation.
- d. Meet in predetermined locations & immediately verify the safety of all personnel.

#### 4.4 After the Event

Once the water has subsided and it isn't predicted to rise again, the area should be returned to the pre-flood condition.

- a. Reopen any sluice gates that were closed, once the water on the river side has receded to 3 inches below the pond level on the protected side.
- b. Open all closure structures and properly store all components.
- c. All temporary protection measures (e.g. sandbags and material placed during temporary levee raises) must be removed and disposed of properly.
- d. Take an inventory of all remaining flood fight equipment, sandbags, plastic, and other supplies. Repair or replace damaged equipment, and restock supplies such as sandbags or plastic in preparation for the next flood event.
- e. Salvage any materials and supplies (e.g. wood from flashboards).
- f. Return all borrowed equipment.
- g. Identify whether remaining materials can be reused within the community.
- h. Inspect the entire flood control work, noting locations of damage and the extent of damage at each location.
- i. Coordinate potential rehabilitation with the Army Corps of Engineers.
- j. Soon after the event, meet with key personnel, volunteer representatives, and community partners to debrief, share remaining concerns, and discuss lessons that were learned during the event.
- k. Revise local emergency plans to account for lessons learned and changes to recommended procedures.
- l. Document the event: keep a map record of the FCW, indicating areas that were in stress at the time of the flooding. This is useful for making repairs or improvements, and for use as a guide to focus attention on these areas during the next flood event.
- m. For future planning, locate and keep records of the flood's high water marks; keep these records along with any rainfall and river data you may have gathered.
- n. Make repairs to the FCW as soon as possible, in preparation for the next flood event.
- o. Initiate actions to provide a permanent means of flood protection, if the existing system relies heavily on temporary solutions during emergencies.

This page intentionally left blank.

## **5. ADDITIONAL SPONSOR RESPONSIBILITIES**

As the public sponsor, you're responsible for ongoing maintenance as discussed in chapter 2, for preparedness activities as discussed in chapter 3, and for flood response activities during high water as outlined in chapter 4. There are several additional requirements that you should be aware of.

### **5.1 Annual Pre-Flood-Season Inspections**

You should have a pre-flood-season inspection program in place for your flood control projects, using information from this manual along with your own experience and resources. The specific maintenance items to look for and some of the corrective actions that should be taken are discussed in detail in chapter 2 of this manual, and the U.S. Army Corps of Engineers' Inspection Guide (Appendix C) can be used as a guide for these inspections. If you'd like more specific advice or information regarding FCW operations, maintenance, or inspections, please contact your Corps district office. When you make these pre-flood-season inspections, you should document the condition of your project in an annual inspection report. Items that would be appropriate to document in this report include:

- The name/ location of the FCW
- The date of the inspection
- The name of the inspector
- What project features were inspected
- The overall condition of the project features
- Maintenance that has been completed
- Maintenance that is being preformed currently
- Maintenance items that need to be accomplished in the future
- Photographs showing flood damages, noted deficiencies, and overall project condition.
- Maintenance costs incurred for the flood control project that year, etc.

### **5.2 Public Awareness Activities**

Many sponsors of flood control projects have trouble finding the funding and support they need to make necessary repairs and improvements. The best examples of well supported levee districts are those that have ensured that local businesses and citizens understand the flood hazard and the importance of the flood control system. While public awareness activities are not required for participation in the RIP, the key to ensuring support from your community lies in promoting a public awareness of the situation. You may be able to promote a greater awareness of key issues through publications and planned public meetings, as described below.

**a. Provide Public Materials**

Flood protection is interesting! Many people will take the time to read through brochures or leaflets detailing local flood protection if this material is provided to them. You might also release annual newsletters or articles for newspapers on the subject. Information should be presented on the following topics:

- i. The areas protected
- ii. The key elements/ equipment in the local flood control system
- iii. How the system works
- iv. The regular impact on the community and ongoing costs for regular operation and maintenance
- v. The consequences if it fails
- vi. Local flood evacuation plans
- vii. Historical overview of past floods and experiences
- viii. Flood response plans and procedures- how the community can contribute

**b. Schedule Public Meetings**

Unless there's an actual flood, attendance at public meetings on flood control may be discouraging, especially if the public is poorly informed on flood control to begin with. You may find it useful to combine such meetings with discussions on local industry or other issues, or to raise certain issues during community events. Always try to involve industry and local groups in your decision making process, so they will support what you're doing.

**5.3 Awareness of Adjacent Systems**

A flood control system is made up of many components, and won't protect you unless they all work together properly. You need to understand how adjacent sections of levee or components on private property impact the larger system. Even though these components might not be situated within your area of responsibility, your community could still be flooded if adjacent systems don't operate properly.

**5.4 Permits**

Whenever you plan to modify the FCW, be sure to get the appropriate local, state, tribal, or federal permits (or waivers for these permits). The process of getting some of these permits may be cumbersome, expensive, and frustrating, and may be more difficult in some states than in others. However, you must be prepared to get these permits in order to comply with the law. If you make changes to your flood control project without first obtaining the necessary permits, you may be denied rehabilitation assistance after a flood, regardless of whether a Corps inspector noticed the changes and asked to view the permits during a Continuing Eligibility Inspection. Please understand that this requirement wasn't invented so that the Corps can deny post flood assistance. Modifications to your FCW don't only affect your own community but can also affect communities upstream and downstream of you as well, or can have a negative impact environmentally; so it's important that any proposed modifications are reviewed and approved by the appropriate parties before you begin construction.



## **5.5 Records**

As the public sponsor, you are responsible for keeping accurate records of all repairs done to the flood control project, including photographs, plans and specifications, as-built drawings, and surveys. Make records of all modifications such as the installation of natural gas pipes, fiber optic cables, and any sewage outfall lines added by commercial companies or municipal agencies. It's important to coordinate these types of changes with the Corps and to provide them with copies of the documents for their files.

To assist you in the proper maintenance of the project, it's also recommended that you keep organized, accurate records of all equipment, maintenance, and inspections. An equipment database file should be maintained that indexes equipment by name or title and contains all pertinent data for that equipment, such as manufacturer's instruction books, operating pressure limits, parts catalogues, manufacturer's drawings, reference field tests, special reports on major requirements, and most importantly, changes in operating procedures. A preventative maintenance database file for things like pump stations should contain equipment inspection, maintenance data, hours of operation, number of operations, and other significant operating data.

This page intentionally left blank.

## 6. REHABILITATION AND INSPECTION PROGRAM (RIP)

### 6.1 Overview of the Rehabilitation and Inspection Program

The U.S. Army Corps of Engineers has authority under Public Law (PL) 84-99 to supplement local efforts to repair flood control projects after they get damaged during a flood. There are many things that must be carefully balanced in carrying out this authority, such as the needs of the local community, sensitivity to the environment, the need to apply sound engineering judgment for the proper functioning of the FCW, and the need to provide proper stewardship of the taxpayers' dollars with which the Corps is entrusted. In light of all these competing interests, the Corps has developed a program called the Rehabilitation and Inspection Program (RIP), which specifically defines the types of projects that can be eligible for assistance, and specifies the ongoing for operation and maintenance requirements for the FCWs that qualify.



Figure 6.1, Levee breach in Lynden, WA

The principal reason the RIP exists is to ensure that flood control works continue to provide reliable protection, so that people's lives, communities, and improved property are protected from floods. The principal benefit of the RIP for you, the public sponsor, is that through this program you can receive federal assistance to help repair your FCW if it becomes damaged in a flood.



Figure 6.2 and 6.3, Levee breaches along the Wabash River

## **6.2 Projects that Qualify**

The Rehabilitation and Inspection Program covers certain levees, channels, floodwalls, flood control dams, retention basins, pump stations, and even some extremely large underground tunnels that have been built for flood control. However, there are certain exclusions to the types of projects that may enter the program. Projects that don't meet the basic criteria below are categorically excluded from the Rehabilitation and Inspection Program. For more information regarding the types of projects that are eligible for the RIP, refer to ER / EP 500-1-1, which can be found through the web-link provided in Chapter 1 of this manual.

### **a. Protecting People and Property**

The principal function of the project must be to protect people or property from floods. If the project was built or is primarily used for any other purpose, such as channel alignment, recreation, fish and wildlife, land reclamation, drainage, or to protect against land erosion or tidal inflows, then it's categorically excluded from admittance in the RIP.

### **b. Public Sponsor**

The project must have a non-federal public sponsor. The public sponsor is the public representative for the project, and represents the interests of any private landowners involved. For example, a levee may be constructed by a county, which would be the public sponsor, on private land for which the county has an easement from the property owners. A public sponsor is a legally constituted public body with full authority and capability to perform the terms of its agreement as the non-federal partner of the Corps for a project, able to pay damages, if necessary, in the event of its failure to perform. The public sponsor may be a state, county, city, town, Federally recognized Indian tribe or tribal organization, Alaska Native Corporation, or any political subpart of a state or group of states that has the legal and financial authority and capability to provide the necessary cash contributions, and the lands, easements, rights-of-way, relocations, and borrow and dredged or excavated materials disposal areas (LERRD's) necessary for the project. Finally, the public sponsor must be legally able to "hold and save" the federal government free from damages that could arise during post-flood rehabilitations or other work the federal government would undertake on the FCW. If it ever becomes necessary to rehabilitate the project, the sponsor will need to sign an agreement limiting the federal government's liability before the Corps will begin any work on the project.

### **c. Reliability**

The project must provide reliable flood protection, and it must be technically sound. To provide complete flood protection, the floodwall or levee must either make a complete a ring around the community, or tie into high ground on both the upstream and downstream ends of the project. From an engineering perspective, it has to be geotechnically stable and properly designed, and it must be well maintained.

**d. Project Completion Required**

The project must be completed. If it's still under construction, it can't enter the RIP.

**e. Minimum Level of Protection**

To be eligible to enter the RIP, agricultural levees (those protecting predominantly agricultural areas or agribusinesses) must be built to provide at least a 5-year level of protection. Urban levees (those protecting land with residences, public or commercial buildings, industrial facilities, etc.) must provide at least a 10-year level of protection. Drainage channels that were designed and constructed for flood control are required to have capacity for a 10 year flood event and must additionally provide drainage to an area 1.5 square miles or greater and have a drainage capacity greater than 800 cfs.

To clarify some of this terminology, a 5-year flood event means that there's a twenty percent chance of this level of flooding every year, not that the flooding actually happens every five years. This means that if an agricultural levee, for example, has a statistical probability of being overtopped more than once every five years, it is categorically ineligible to be in the RIP.

Drainage structures that were specifically constructed for flood control as components of a larger FCW system (such as ponding areas or channels carrying water from the ponding area up to and through a levee) are considered to be components of the overall FCW system. They would be evaluated for inclusion in the RIP and potential rehabilitation with the remainder of the FCW. However, natural or modified streams within a levee'd area, including drainage swales such as roadside ditches, are not considered to be components of flood control works and would not be included in the RIP.

**f. Primary Levee Requirement**

In the case of a levee project, the levee must be a primary levee. Secondary levees are not eligible to enter the rehabilitation program. Exceptions to this policy may be granted if the secondary levee was designed to protect human life or the levee is a major component of the primary levee system and is necessary to assure the flood control protection of the total system.

**g. Construction Compliance**

The project must have been constructed in accordance with all applicable federal, state and local permits, codes, ordinances, and applicable laws. This includes flood plain management ordinances in counties where no flood insurance programs exist.

This page intentionally left blank.

## 7. CORPS INSPECTIONS

The U.S. Army Corps of Engineers has established minimum standards for the construction, operation, maintenance, and preparedness of flood control works that must be met in order for the FCW to be eligible for federal rehabilitation assistance after a flood. This chapter describes the inspections that the Corps conducts in order to monitor the condition of levees, floodwalls, channels, and other FCWs. The information described in this chapter is supplemented in a flowchart in Appendix B, which summarizes the relationships between the Corps' inspections and the status of a project's eligibility for rehabilitation assistance. Additional information on the Corps' inspections can be found in Appendix C, which is the Inspection Guide used during all Corps inspections of non-federal FCWs.



**Figure 7.1.** *Inspection of pumping station controls. (OK)*

One important note on Corps inspections and project ratings is that individual sponsors are not treated completely independently, but the Corps inspects and rates the entire “hydrologically independent” flood control project as one system. This means that if there are multiple public sponsors with responsibility over sections of a single flood control system, then they’ll all pass or fail their inspections together. This only makes sense, because the entire area will flood if one section fails during high water. It’s the responsibility of the multiple public sponsors, not of the Corps, to coordinate all necessary responsibilities and obligations under the RIP.

### 7.1 Entering the RIP – The Initial Eligibility Inspection (IEI)

To enter the RIP, you should contact your local Corps Emergency Management Office. Upon receiving a request to join the RIP, the Corps will conduct an Initial Eligibility Inspection (IEI) of your non-federal flood control project, which will include an evaluation of the technical capabilities of your project, as well as a review of project operation, maintenance, and preparedness. The purpose of the IEI is to determine whether the project meets the specific minimum criteria and standards set forth by the Corps for providing reliable flood protection.

**Active:** A status applied to flood control projects concerning their participation in the Rehabilitation and Inspection Program under authority of PL 84-99. An Active project has met the Corps' criteria for entry into the program, and continues to meet ongoing criteria for continuing eligibility. Only Active projects may receive PL 84-99 rehabilitation assistance to repair damage caused by a flood event or coastal storm.

During the IEI, the Corps will evaluate things such as the standards of construction, physical location of the FCW, the cross-section of levees, and the elevation of levees and floodwalls in relation to the anticipated flood levels. The Corps normally conducts IEIs when FCWs are undamaged during low water or normal water-level

conditions. This allows for more of the FCW to be inspected, so the condition of the project can be determined more accurately.

After the IEI is conducted, you'll receive a letter with the inspection results. If your project is rated "Acceptable," it is immediately placed in an Active status in the RIP. If it's rated Minimally Acceptable, it's placed in an Active status in the RIP and the letter will indicate the deficiencies that would need to be corrected in order for your project to meet the Corps' standards for entering the program, as well as a time frame for making these repairs. If the project is rated Unacceptable, the sponsor will be notified of the inspection results and the project will be placed in an Inactive status in the RIP (or may not be entered into the program at all). In this case, the deficiencies may have come from poor maintenance, or from more fundamental aspects of the FCW such as inadequate elevation or cross section in relation to the anticipated flood levels. Further inspections of a project receiving an IEI rating of Unacceptable will not be made until the Corps has been notified in writing that such corrective action work has been completed. If you don't agree with the results of the Corps' evaluation, you may choose at your own expense to provide a detailed engineering study (certified by a licensed professional engineer) of the FCW and request that the Corps reconsider its evaluation.

## **7.2 Maintaining Active Status – Continuing Eligibility Inspections (CEIs)**

To maintain an Active status in the RIP, you're required to provide ongoing maintenance of the project. The Corps monitors this ongoing maintenance through Continuing Eligibility Inspections (CEIs), which are conducted at least every other year, though many Corps districts have elected to hold them on a more frequent basis in order to ensure compliance with the requirements of the RIP. CEIs typically don't go into the same level of detail that IEIs do, since project features such as elevation or cross section don't need to be reevaluated during continuing inspections. However, the majority of project components are inspected using the same criteria that were used during the Initial Eligibility Inspection.

If, during the CEI, the FCW is found to meet the Corps' standards for the RIP program, it will remain Active in the RIP. If it's found to be "Minimally Acceptable," based on deficiencies in some area of operation or maintenance, you'll be required to correct the noted deficiencies, and will be given a timeframe to make those repairs. If the repairs are completed to the Corps' specifications, the FCW will remain Active in the program. If the repairs are not completed within a timeframe, the FCW will be put into an Inactive status in the RIP. If the FCW is given an "Unacceptable" rating, then the FCW will immediately be put into an Inactive status in the RIP. You will regain your Active status as soon as you send the Corps documentation showing that the repairs are complete.



### 7.3 Inspection Methodology

Using the Inspection Guide found in Appendix C, each of the individual items or components of the project are rated according to the following table:

<b>INDIVIDUAL ITEM / COMPONENT RATING</b>		
<i>SYMBOL</i>	<i>CONDITION</i>	<i>DEFINITION</i>
<b>A</b>	<b>Acceptable</b>	The rated item is in satisfactory, acceptable condition, and will function as designed and intended during the next flood event.
<b>M</b>	<b>Minimally Acceptable</b>	The rated item has a minor deficiency that needs to be corrected. The minor deficiency will not seriously impair the functioning of the item during the next flood event. The overall reliability of the project will be lowered because of the minor deficiency.
<b>U</b>	<b>Unacceptable</b>	The rated item is unsatisfactory. The deficiency is so serious that the item will not adequately function in the next flood event, compromising the project's ability to provide reliable flood protection.

Once each project feature is rated, the inspector will look through the list of rated items to identify the lowest rating that was given for a project feature. The overall project is rated based on the lowest-rated project feature, and the overall project status is confirmed as either Active or Inactive in the RIP depending on the overall project rating.

<b>DETERMINATION OF OVERALL PROJECT RATING AND PROJECT STATUS</b>		
<b>If the lowest rated project component is:</b>	<b>Then this results in an overall project rating of:</b>	<b>And the project status in the RIP is:</b>
Acceptable	Acceptable	Active
Minimally Acceptable	Minimally Acceptable	Active, though status is contingent upon completion of required work.
Unacceptable	Unacceptable	Inactive

Finally, the overall project ratings are defined as follows:

<b>OVERALL PROJECT RATING</b>		
<i>SYMBOL</i>	<i>CONDITION</i>	<i>DEFINITION</i>
<b>A</b>	<b>Acceptable</b>	No immediate work required, other than routine maintenance. The flood control project will function as designed and intended, with a high degree of reliability, and necessary cyclic maintenance is being adequately performed.
<b>M</b>	<b>Minimally Acceptable</b>	One or more deficient conditions exist in the flood control project that needs to be improved / corrected. However, the project will essentially function as designed and intended, but with a lesser degree of reliability than what the project should provide. Specific items of the project must be improved / corrected.
<b>U</b>	<b>Unacceptable</b>	One or more deficient conditions that can reasonably be foreseen to prevent the project from functioning as designed, intended, or required.

This page intentionally left blank.

## **8. REHABILITATION ASSISTANCE**

The purpose of this chapter is to provide information on the rehabilitation assistance that the U.S. Army Corps of Engineers can provide if an FCW is damaged during a flood. It describes the criteria that must be met before this assistance can be given, as well as the process for requesting it and the types of activities to which this assistance can be applied. Although the rehabilitation assistance described in this chapter can only be given to those FCWs with Active status in the RIP, Chapter 9 lists additional types of emergency assistance the Corps can provide regardless of your participation or status in the RIP.

### **8.1 Requesting Rehabilitation Assistance**

In the event of a significant flood, the Army Corps of Engineers District Commander will declare the flood an emergency. Immediately after the declared flood subsides (when the river goes back down to its bank full condition and is not predicted to rise again), the Corps district will issue a “Notice to Public Sponsors,” which lets you, as the public sponsor, know that the Corps is accepting requests for rehabilitation. If your project was damaged during the flood, you’ll typically be given 30 days to respond to this notification and submit a formal, written request for rehabilitation assistance. A sample request form can be found in Appendix E.

### **8.2 Requirements for Receiving Rehabilitation Assistance**

Upon receipt of your request, the Corps will first determine whether the repairs would be eligible for rehabilitation assistance. There are a number of requirements that must be met before the Corps will provide this assistance:

**a. The FCW must have an Active status in the RIP.**

**b. The FCW must have been damaged by a flood or coastal storm**

Damages by non-flood events, regardless of whether they are natural or man-made, are generally not eligible for Corps assistance under the RIP.

**c. Cost / Benefit Calculation**

To determine whether the cost of the repair is economically justified, the Corps will calculate the benefits and the costs of the repair using standard principles and guidelines for water resource projects. The calculated benefits will be based on the benefits to the entire area protected by the complete (hydrologically independent) flood control system, and the calculated repair costs will reflect the flood damages along the complete flood control system. To qualify for rehabilitation assistance, the benefits of the repair must outweigh the cost.

**d. Construction Cost Minimum Requirement**

The construction cost of the repair must be more than \$15,000. There are several reasons for this policy. First, damages under \$15,000 are considered to be routine maintenance that the public sponsor must undertake at its own expense. Second, before the Corps can undertake any project, specialists from many different disciplines must review the project. These specialists ensure that real estate and rights-of-way are

available, review environmental and endangered species considerations, and verify that the Corps is legally and financially correct in undertaking the repair. This work must be done regardless of how big or small the job is. Because of the considerable cost of undertaking this background work, small repair jobs simply don't justify all of the work needed for Corps involvement.

### **8.3 Cooperation Agreements**

If these qualifications are met, then a cooperation agreement will be prepared. The cooperation agreement is a contract between you, as the public sponsor, and the Corps. It clarifies the details of the rehabilitation, including the specific work to be done, and sponsor requirements of cost sharing and local cooperation. The Corps will prepare this document following the format in Appendix F. The sponsor and the District Engineer must sign the cooperation agreement before the rehabilitation can begin, and there could be additional costs involved if it takes more than 30 days for you to sign the document once it's complete.

The cooperation agreement outlines the cost breakdown for the work. The following sections outline the types of items that will typically be paid for by the US government, the items that are typically cost shared, and the items that you would usually be responsible for at 100 % local cost. Keep in mind that this isn't a complete list, and that certain details have been omitted for brevity. Specific details concerning the cooperation agreement can be found in paragraph 5-10 of ER 500-1-1 and in paragraph 5-13 of EP 500-1-1.

#### **a. Rehabilitation components typically covered at 100% Federal cost**

The Corps will fund, at 100% federal cost, costs associated with the preparation and approval of Preliminary Investigation Reports, as well as the engineering and design costs for approved projects.

#### **b. Items typically cost shared at 80% Federal and 20% Local cost**

Cost sharable items include construction costs, contingency costs for construction, and supervision and administration (S&A) costs.

There are several details you should know about your 20% local cost share contribution. Most importantly, it may be a combination of cash or work in kind. The value of work in kind is determined by the Corps as the estimated cost that the Corps would have to pay if it was to perform or contract for the same work. (Be aware that the Corps won't reimburse you for work in kind that you contribute beyond your 20% requirements.) Also, cash contributions could potentially include funds from other federal agencies, as long as the other agency confirms in writing that their money can legally be spent on the rehabilitation.

**c. Items you are responsible for at 100% local cost**

These items do not constitute credit towards your 20% local cost share, but are additional costs for which you will be responsible.

**i. LERRDs**

All suitable Lands, Easements and Rights-of-way, including borrow and dredge material disposal areas, and relocations (e.g., roadways, utilities, etc.) that are necessary to perform the required repairs and to secure the necessary permits.

**ii. Betterments**

Any construction effort that increases the protected area, provides features that did not exist prior to the flood event, or increases the degree or level of protection provided by the FCW are considered betterments, and are not eligible for funding under the RIP. Examples of betterments might include increasing the height of a levee, or the placement of riprap where none previously existed. Repairs that incorporate modern materials or technologies commonly incorporated into current designs (for example, the use of geotextile fabric) are not considered betterments and may be cost shared as part of the rehabilitation work.

**iii. Deliberate Levee Cuts**

Rehabilitation assistance will generally not be provided for the repair of levees that were deliberately breached by the public sponsor. For example, as river levels begin to recede after a flood, a public sponsor may wish to intentionally breach the levee in order to let out ponded water. The repairs for this deliberate levee cut would not be eligible for rehabilitation assistance.

However, there may be cases when the Corps acknowledges a valid need for a deliberate levee cut in order to protect the integrity of the levee (or adjacent levee system) and minimize overall damages from a flood. If you consult with the Corps before making a deliberate levee cut and the Corps specifically approves the cut, then an exception would be made to the above policy and rehabilitation assistance could be provided to repair the breach.

**iv. Repairs that wouldn't be the least cost alternative to the Federal Government**

If you prefer an alternative method of repair that is not the least cost alternative, you are responsible for paying 100% of the cost difference between the two alternatives. For example, the transportation of borrow material from the closest acceptable borrow source (as determined by the Corps) is a cost sharable item (80/20). However, if you wanted to use borrow material from a further source, then you're responsible for paying for 100% of the transportation costs beyond what would have been incurred, had you opted for the closer source.

## **v. Maintenance Deficiencies**

If maintenance deficiencies are noted during a routine inspection, and your project is rated “Minimally Acceptable,” you will be given a period of time to make the repairs. If the maintenance is still outstanding when there is a flood, you are still responsible for 100% of the cost of this deferred maintenance. The maintenance repairs must be completed either prior to or concurrently with any approved project rehabilitation. It may be possible to have the Corps make the repairs along with the project rehabilitation, but the cost associated with the deferred maintenance is still your responsibility, and will be added to your 20% cost-share for the rehabilitation. To clarify this issue, here are two examples of deferred maintenance that would be the responsibility of the public sponsor:

### **Deferred Maintenance Example 1: Flap Gate Requires Maintenance**

During a CEI, it was found that a flap gate for a culvert was not closing properly and required maintenance. After the CEI and before the public sponsor fixed the problem, there was a flood. Because the flap gate didn’t close properly, the levee around the culvert was eroded, necessitating earthwork and a new culvert. The public sponsor will be responsible for 100% of the cost of repairing the flap gate. Depending on the circumstances and the actions the local sponsor had taken to repair the flap gate and reduce the amount of flood damage, the sponsor may be responsible for replacing the culvert and the damage to the levee as well.

### **Deferred Maintenance Example 2: Rusted Metal Pipe**

A corrugated metal pipe runs through the levee. Over time, it has rusted significantly, and is in danger of failure. It’s noted in a CEI that the pipe needs to be replaced. Even though the repair of the pipe would be a large expense, this type of repair is considered to be part of regular maintenance and is the sponsor’s responsibility. If the pipe collapses and causes the levee to fail at this location during a flood, the sponsor is not only responsible for the cost of a new pipe and installation, but also for the complete cost of repair to the surrounding levee. (If the pipe fails but the levee failure was unrelated to the rusted pipe, then the Corps may assist with the repairs, but the sponsor would still be responsible for replacing and installing a new pipe.)

#### **8.4 Nonstructural Alternatives to Rehabilitation**

If your FCW is damaged in a flood and is eligible for rehabilitation assistance, the project could be repaired as previously discussed, or you could request a Nonstructural Alternative Project (NSAP) in lieu of the structural repair. This option essentially allows you to use the federal funding that would have been authorized to rehabilitate your flood control work, and apply it towards the restoration of the flood plains or floodways that were originally in your area. Because of this, you would typically only choose a nonstructural alternative (NSA) once you were absolutely sure that you no longer wanted to rely on your FCW to protect you from floods. Some of the things an NSA might fund include the acquisition of land for the project, the removal of utility connections and other structures, the total or partial removal of levee reaches, and the restoration of natural habitats. If you're thinking of requesting an NSA, remember that the Corps may, in its sole discretion, reject a request for an NSA if it believes that the project would lead to significantly increased flood protection expenses, would negatively impact adjacent or nearby FCWs, or would lead to increased risk to life or property during flood events. Once an NSAP is implemented, the project is no longer eligible for rehabilitation assistance because it will no longer be functioning as a flood control project.

This page intentionally left blank.



## **9. OTHER TYPES OF ARMY CORPS OF ENGINEERS EMERGENCY ASSISTANCE**

Whereas the rehabilitation assistance described in the previous chapter is only provided to sponsors of flood control works that have an Active status in the RIP, the purpose of this chapter is to present information on other emergency related assistance the U.S. Army Corps of Engineers can provide you, regardless of your participation or status in the RIP. In fact, the assistance described in this chapter may be provided regardless of whether there is any Flood Control Work protecting your community. The other types of assistance authorized under PL 84-99 include technical assistance with preparedness activities such as planning and training, advance measures assistance, direct assistance during and immediately after a flood, and emergency water assistance which may be provided during droughts or when your primary water source becomes contaminated.

It should be noted that all of the assistance described in this chapter would be of a temporary nature to meet immediate threats, and is not intended to provide permanent solutions to flood or water problems. Remember that the Corps will only provide these types of assistance after local and state authorities have committed all available resources and are still unable to cope with the situation, and in some cases will only do so if the benefits of constructing the project are found to outweigh the cost of the construction. Finally, except in the case of technical or direct assistance, the Corps will only consider requests for these categories of assistance if they come from the governor of a state, or from a Native American tribal leader. If you, as the public sponsor, believe that one of these types of assistance would be appropriate in your situation, first speak with your Corps district office to determine what sorts of details would need to be included in the request, and then coordinate your request so that it comes to the Corps through the proper official channels.

### **9.1 Technical Assistance**

The Corps is authorized to furnish technical assistance to local authorities at their request, advising them in their efforts to maintain the integrity of their FCWs. Technical assistance consists of providing technical review advice, and/or recommendations in support of state and local agency efforts, and helping determine feasible solutions to uncommon situations. The following are examples of technical assistance:

#### **a. Provision of Experienced Personnel**

Providing experienced Corps personnel to inspect existing FCWs and/or structurally threatened dams to identify potential problems and recommend corrective measures, to evaluate conditions to determine the requirements for additional flood control protection, and to recommend the most expedient emergency construction methods.

#### **b. Flood fight Techniques**

Providing personnel to give guidance on flood fight techniques.

**c. Hydraulic, Geotechnical and Topography**

Providing hydraulic or hydrologic analysis, geotechnical evaluations, topography and available stream data, maps, and historic flood or storm information.

**d. Provision of Information**

Providing information, which is readily available at Corps districts, for use in the preparation of local evacuation and/or contingency flood plans.

**9.2 Direct Assistance**

The Corps is authorized under PL 84-99 to provide direct assistance to local communities in response to flooding or coastal emergencies. Direct assistance may include, but is not limited to, issuing supplies, the loan of flood fight supplies and equipment, assistance with contingency contracting during emergencies, and supplemental support to aid local authorities in rescue operations and in the direction of flood fight operations. This is done in order to protect public facilities, residences, or improved property from flooding, or when there's a potential for loss of life. As a matter of policy, the Corps limits its flood fight activities on agricultural levees to technical assistance. Direct assistance does not need to be requested by the governor of a state, and may initially be granted based on a verbal request, though a written request must follow and a signed cooperation agreement must be signed before it can be provided. Legal responsibility for the actions remains with the requesting state or local official. For more details on direct assistance, please contact your local Corps district.

**9.3 Advance Measures Assistance**

Advance measures assistance is another type of assistance available under authority of PL 84-99. Advance measures assistance is provided when there is a clear prediction that there is an imminent threat of unusual flooding, which would result in substantial flood damages to an area if no preventative action is taken in advance of the flooding. Advance measures assistance is provided prior to the predicted unusual flooding, and can include technical and/or direct assistance such as supplies, equipment, and/or emergency contracting, through which the Corps may be able to repair, strengthen, or temporarily raise your flood control projects, or remove stream obstructions. However, there are several key qualifications to this type of assistance that significantly restrict the types of situations where it can be provided, and these are listed below. Please contact your local Corps district for the terms of local cooperation, for details on the governor's request, or for other details regarding this assistance.

**a. Imminent Threat & Unusual Flooding**

The Corps must determine that an "imminent threat" of "unusual flooding" exists in order to approve advance measures projects. The evaluation of the threat must come from an objective, statistically supported source like the National Weather Service. The determination of what qualifies as "unusual flooding" is subjective, but for example, if it has been predicted that the flooding will approach an area's flood of record or will be greater than a 50-year level of flooding, these may be considered unusual flood events. Be aware, however, that some areas of the country get flooded so frequently that sometimes even a 50-year flood isn't always considered a particularly unusual event. Again, this is a subjective determination that's made by the Corps.

**b. Project Investigation Report**

The Corps will prepare a project investigation report before advance measures assistance is provided. This report is needed to evaluate and justify the construction of an advance measures project, and this particular type of assistance wouldn't be given in cases where there wouldn't be sufficient time to complete this investigation before the flooding is expected.

**c. Temporary Protection Only**

Advance measures projects will only be constructed to provide temporary protection from flooding, and must be removed or upgraded by the public sponsor to meet federal flood protection standards, after the flood threat has passed. This assistance is not to be used as a means of circumventing the normal authorization process to have the Corps construct more permanent FCWs, and is not to be used as a "quick fix" for local agencies that do not adequately perform regular and routine maintenance.

**9.4 Post Flood Assistance**

Immediately following a major flood, hurricane, or coastal storm, the governor of your state may request post flood assistance, in writing, from the District Engineer. This request must be made concurrently with or immediately after the governor's request to FEMA for a disaster declaration under the Stafford Act. Post flood assistance may be either technical or direct assistance and is limited to actions to save lives and protect improved property. The Corps may assist in clearing flood-deposited debris in order to reopen critical transportation routes (to provide access to medical facilities, for example), or to clear watercourses, drainage channels, bridge openings, water intakes, sewer outfalls, or other structures, if critical for the restoration of public services, public safety or to prevent further significant damage. This assistance may be provided for a maximum of ten days of receipt of the governor's request. No work will be performed after the 10-day period expired, or initiated subsequent to a presidential disaster declaration or denial.

The assistance won't be provided directly to individual homeowners, businesses, or agricultural property, and won't be provided for efforts to collect post-flood data. Please contact your local Corps district for details on the governor's request, for the terms of local cooperation, or for other details regarding this type of assistance.

**9.5 Emergency Water Assistance**

If requested by the governor of a state, the Corps may provide temporary emergency water for human consumption to drought distressed areas or to those areas with contaminated water sources in order to meet minimum public health and welfare requirements. Long-term solutions to water supply problems are the responsibility of state and local interests. Typically, the Corps will fund the transportation of water to areas with extreme drought, but will not purchase the actual water. For more details on this type of assistance, please contact your Corps district office.

This page intentionally left blank.

# APPENDIX A: ACRONYMS AND DEFINITIONS

## Section I - Acronyms

**AR** - Army Regulation

**BCR** - Benefit Cost Ratio

**CEI** - Continuing Eligibility Inspection

**CFR** - Code of Federal Regulations

**EM** - Engineer Manual, Emergency Manager, Emergency Management

**EOC** - Emergency Operations Center

**EP** - Engineer Pamphlet

**ER** - Engineer Regulation

**FCCE** - Flood Control and Coastal Emergencies

**FCW** - Flood Control Work

**ICW** - Inspection of Completed Works

**IEI** - Initial Eligibility Inspection

**LERRDs** - Lands, easements, rights-of-way, relocations, and borrow and dredged or excavated materials disposal areas.

**NSAP** - Nonstructural Alternatives Project

**O&M** - Operations and Maintenance

**OMRR&R** - Operation, Maintenance, Repair, Replacement, and Rehabilitation

**PCA** - Project Cooperation Agreement.

**PIR** - Project Information Report

**PL** - Public Law

**RIP** - Rehabilitation and Inspection Program

**USACE** - U.S. Army Corps of Engineers

**USC** - United States Code

**WRDA** - Water Resources Development Act

## Section II - Definitions

**Active.** A status applied to FCWs concerning participation in the Rehabilitation and Inspection Program under authority of PL 84-99. An Active project must have met the Army Corps of Engineer's criteria for entry and been entered into the RIP. Only Active projects may receive rehabilitation assistance to repair damages caused by a flood event or coastal storm.

**Agricultural Levee.** A levee that provides at least a 5-year level of flood protection to predominantly agricultural areas or agribusinesses. May be federal or non-federal.

**Betterment.** During repair of an FCW, any construction effort that increases the area protected, provides features that did not exist prior to the flood event, or increases the degree or level of protection provided by the FCW. Examples of betterments include increasing the height of a levee, or providing riprap where none previously existed.

**Channel.** A natural or artificial watercourse with definite bed and banks to confine and conduct flowing water.

**Channel Capacity.** The maximum flow that can pass through a channel without overflowing the banks.

**Cooperation Agreement.** An agreement entered into by a District Commander (acting as the agent for the Department of the Army on behalf of the United States Government) and the public sponsor for the purpose of identifying each party's rights and obligations concerning the expenditure of federal funds under authority of PL 84-99.

**Deflection Weir.** Also known as a bendway weir, this is a structure (earth, rock, or timber) built part way across a river for the purpose of controlling erosion and maintaining the navigation channel.

**Deliberate Levee Cut.** A deliberate cut made in a levee, with the intention of either protecting the integrity of the structure (or an adjacent structure) from actual or forecasted river stages, or reducing the overall anticipated damages expected to occur to the existing structure by the current flood event. See also Dewatering Levee Cut.

**Dike.** In some areas of the United States, this term is used synonymously with levee. In other areas, it is used for the kind of structure referred to in this manual as a deflection, or bendway weir. Some people use it exclusively to refer to the salt-water version of a levee, designed to protect an area from sea water. Since this term is used so differently by different people, "dike" isn't used in this manual.

**Drainage Structure.** Generally, any feature or system (e.g., culverts) constructed for the purpose of discharging surface water run-off. Such structures are components of interior drainage systems.

**Eligible Levee.** A levee categorized as "Active" in the RIP, for which the Army Corps of Engineers can provide assistance under authority of PL 84-99 to repair damage caused by a flood event.

**Emergency.** A situation involving a natural or technological disaster that would result in an unacceptable hazard to human life, a significant loss of property, or significant economic hardship.

**Emergency Preparedness.** All those activities and measures designed or undertaken to prepare for or minimize the effects of a hazard upon the civilian population, to deal with the immediate emergency conditions that would be created by the hazard, and to effectuate emergency repairs to, or the emergency restoration of, vital utilities and facilities destroyed or damaged by the hazard.

**Federally Authorized Projects/Federal Projects.** An FCW project built by the Army Corps of Engineers that was authorized for construction by Congress or by the Corps' continuing authorities (e.g., Section 205.)

**Federal FCW/Federal Levee.** A Federally authorized FCW, levee, or levee system project. FCWs constructed by non-federal interests, or other (non-Corps) federal agencies, and incorporated into a federal system by specific Congressional action (i.e., United States law) are also designated as federal FCWs. Construction by, or previous rehabilitation or reconstruction of a non-federal FCW by a federal Agency (to include the Army Corps of Engineers, FEMA, NRCS, and EDA) does not make the levee a federal levee. Levees constructed under the authority of the Works Progress Administration are not federal levees. Section 14 projects constructed under authority of PL 79-526 are not federal FCWs.

**Flood.** Abnormally high water flow or water level that overtops the natural or artificial confining boundaries of a waterway. A general and temporary condition of partial or complete inundation of normally dry land areas from the overflow of river and/or tidal waters and/or the unusual accumulations of waters from any sources.

**Flood Control Project.** See flood control work.

**Flood Control Work(s) (FCW).** Structures designed and constructed to have appreciable and dependable effects in preventing damage caused by irregular and unusual rises in water level. FCW may include levees, channels, floodwalls, dams, and Federally authorized and constructed hurricane or shore protective structures. Structures designed and constructed to protect against salt water intrusion or tidal fluctuations, channel alignment, navigation, recreation, fish and wildlife, land reclamation, or to protect against land erosion are not considered to be FCWs. A riprap bank erosion control structure is not considered to be a flood control work.

**Flood Fighting.** Actions taken immediately before or during a flood to protect human life and to reduce flood damages, such as evacuation, emergency sandbagging, and providing assistance to flood victims.

**Flood Plain.** Any normally dry land area that is susceptible to being inundated by any natural source, such as a stream, during floods. The Army Corps of Engineers, as a matter of policy, encourages local governments to zone their flood plains against development and thereby avoid property damage and reduce obstruction to passage of floodwaters.

**Flood Stage.** The water surface elevation of a river, stream, or body of water, above which flooding and damages normally begin to occur, normally measured with respect to a specific reference gage. Flood stage is normally the level at which a river overflows its banks. Flood stage for any particular geographic area is unique to that geographic area.

**Floodwall.** A type of flood control work usually constructed of stone or reinforced concrete, and which may occasionally have plastic or steel components. Floodwalls are generally constructed in urban areas where insufficient area exists to construct earthen levees.

**Floodway.** Designated land left essentially clear of development, for the purpose of passing floodwaters. In some areas, floodway is used to designate the 100-year flood plain.

**Freeboard.** A factor of safety usually expressed in feet above a flood level for purposes of designing flood protection facilities and for floodplain management. Freeboard tends to compensate for the many uncertain factors that could contribute to flood heights greater than the height calculated for a selected size flood and floodway conditions, such as wave action, bridge obstructions, and the hydrological effect of urbanization of the watershed. Freeboard is being replaced as a technique through risk and uncertainty management.

**Haul Road.** Any privately owned road used by Corps vehicles or Corps contractor's vehicles to haul rock, earth fill, or other borrow materials to the site of a repair/flood fight/rehabilitation effort, or on which empty vehicles return. This includes haul roads specifically constructed for a repair/rehabilitation effort. Also included are levee crown roads and levee patrol roads that are not public roads, if their principal purpose is for access for maintenance, inspection, and flood fight purposes. All public roads are specifically excluded, to include any public roads that are situated on levees.

**Hundred Year Flood.** More accurately referred to as a "one percent chance flood," a flood of a magnitude that, according to historical statistics, has one chance in one hundred of occurring in any given year.

**Imminent Threat.** A subjective, statistically supported evaluation of how quickly a threat scenario can develop, how likely that threat is to develop in a given geographical location, and how likely the threat will produce catastrophic consequences to life and improved property. Implicit in the timing aspect can be considerations of time (e.g., a storm front's predicted path) or season (e.g., a snowpack that will melt in the coming spring runoff) or of known cyclical activities (e.g., rising water levels in the Great Lakes), but occurring inside the normal Corps decision and execution cycle for small project construction.

**Inactive.** A status applied to FCW concerning participation in the RIP. An Inactive project is, simply, any project that is not Active. It includes formerly Active FCW that left Active status in the RIP, either voluntarily or involuntarily, as well as those FCW that have never been Active in the RIP. See also "Active."

**Initial Repair.** A hastily effected temporary repair of a breached levee that provides a 10- to 25-year level of protection for a short (less than 12 month) period of time until the permanent repair can be designed and executed.

**Interior Drainage.** Natural or modified outflow of streams within a levee'd area for the conveyance of run-off. Interior drainage systems are not components of flood control works.



**LERRDs.** Lands, easements, rights-of-way, relocations, and borrow and dredged or excavated materials disposal areas.

**Levee.** A structure, normally of earth or stone, built generally parallel to a river to protect land from flooding. A levee is a complete unit, designed and intended for flood control. A levee (excluding a ring levee) is always tied to high ground at both ends.

**Level of Protection.** The degree of protection against flooding provided by an FCW, normally expressed in terms of the cyclical flood-level against which protection is provided.

**Local Cost Share.** That portion of the cost of undertaking assistance authorized under PL 84-99 (e.g., repairing a damaged Active levee) for which the public sponsor is responsible. The local cost share may be paid either in cash or as work-in-kind, or as a combination of the two.

**Major Flood.** A flood event determined to be a 100-year event or better, or a series of weather events over a short period of time (normally seven days or less), which causes loss of human life and/or property damage exceeding \$1 million.

**Non-Federal Levee/Non-Federal Project/Non-Federal FCW.** A flood control work not authorized by Congress, or under other federal agency authority. Works Progress Administration (WPA) projects are considered non-federal FCW for the application of PL 84-99 authority.

**Nonstructural Alternative Project.** A type of project, authorized by an amendment to PL 84-99 contained in WRDA 96, that, in lieu of a structural rehabilitation effort, allows for restoration of floodways, flood plains, and/or the reduction of future flood damages and associated FCW rehabilitation costs.

**Political Subdivision.** A city, town, borough, township, county, parish, district, association, or other public body created by or pursuant to state law and having jurisdiction over the water supply of such public body.

**Project Cooperation Agreement.** An agreement entered into by a District Commander (acting as the agent for the Department of the Army on behalf of the United States Government) and the public sponsor for the purpose of identifying each party's rights and obligations concerning the expenditure of federal funds under the Army Corps of Engineers' authority other than that of PL 84-99. See also Cooperation Agreement.

**Public Sponsor.** A public sponsor is a legally constituted public body with full authority and capability to perform the terms of its agreement as the non-federal partner of the Corps for a project, and able to pay damages, if necessary, in the event of its failure to perform. A public sponsor may be a state, county, city, town, Federally recognized Indian tribe or tribal organization, Alaska Native Corporation, or any political subpart of a state or group of states that has the legal and financial authority and capability to provide the necessary cash contributions and lands, easements, rights-of-way, relocations, and borrow or dredged or excavated material disposal areas (LERRD's) necessary for the project.

**Rehabilitation and Inspection Program (RIP).** A component of the Civil Emergency Management Program concerned with the inspection and rehabilitation of FCWs.

**Rehabilitation Assistance.** Repair and restoration under authority of PL 84-99 of an Active FCW damaged in a flood event.

**Rehabilitation Project.** An action or series of actions focused on the repair of an Active flood control work to return the FCW's level of protection to its pre-flood/pre-storm level.

**Repair and Rehabilitation.** The terms "repair", "rehabilitation", or "repair and rehabilitation" mean the repair or rebuilding of a flood control structure, after the structure has been damaged by a flood, hurricane, or coastal storm, to the level of protection provided by the structure prior to the flood, hurricane, or coastal storm. The terms do not include improvements (betterments) to the structure, nor does "repair and rehabilitation" include any repair, reconstruction, or rehabilitation activities of a flood control structure which, in the normal course of usage, has become structurally unsound and is no longer fit to provide the level of protection for which it was designed.

**Saturation.**

(1) **Soil Saturation.** A condition in soil in which all spaces between the soil particles are filled with water. Such conditions normally occur after prolonged periods of rainfall and/or snowmelt. The result of a saturated condition is that any additional rainfall or snowmelt runs off into streams and rivers instead of soaking into the ground.

(2) **Levee saturation.** Soil saturation that has occurred in an earthen levee because of floodwaters remaining above flood stage for extremely long periods of time. This condition can lead to catastrophic failure of the levee.

**Secondary Levee.** A levee that is landward of the main or principal levee. The level of protection of a secondary levee is always less than the level of protection provided by the main levee.

**Stream.** A body of water flowing in a definite natural or manmade course that has the potential to flood. The term stream refers to rivers, streams, creeks, brooks, etc., and includes intermittent streams that are subject to flooding.

**Unusual Flooding.** For use with Advance Measures, a subjective determination that considers potential ability to approach an area's Flood of record, a catastrophic level of flooding, or a greater than 50-year level of flooding.

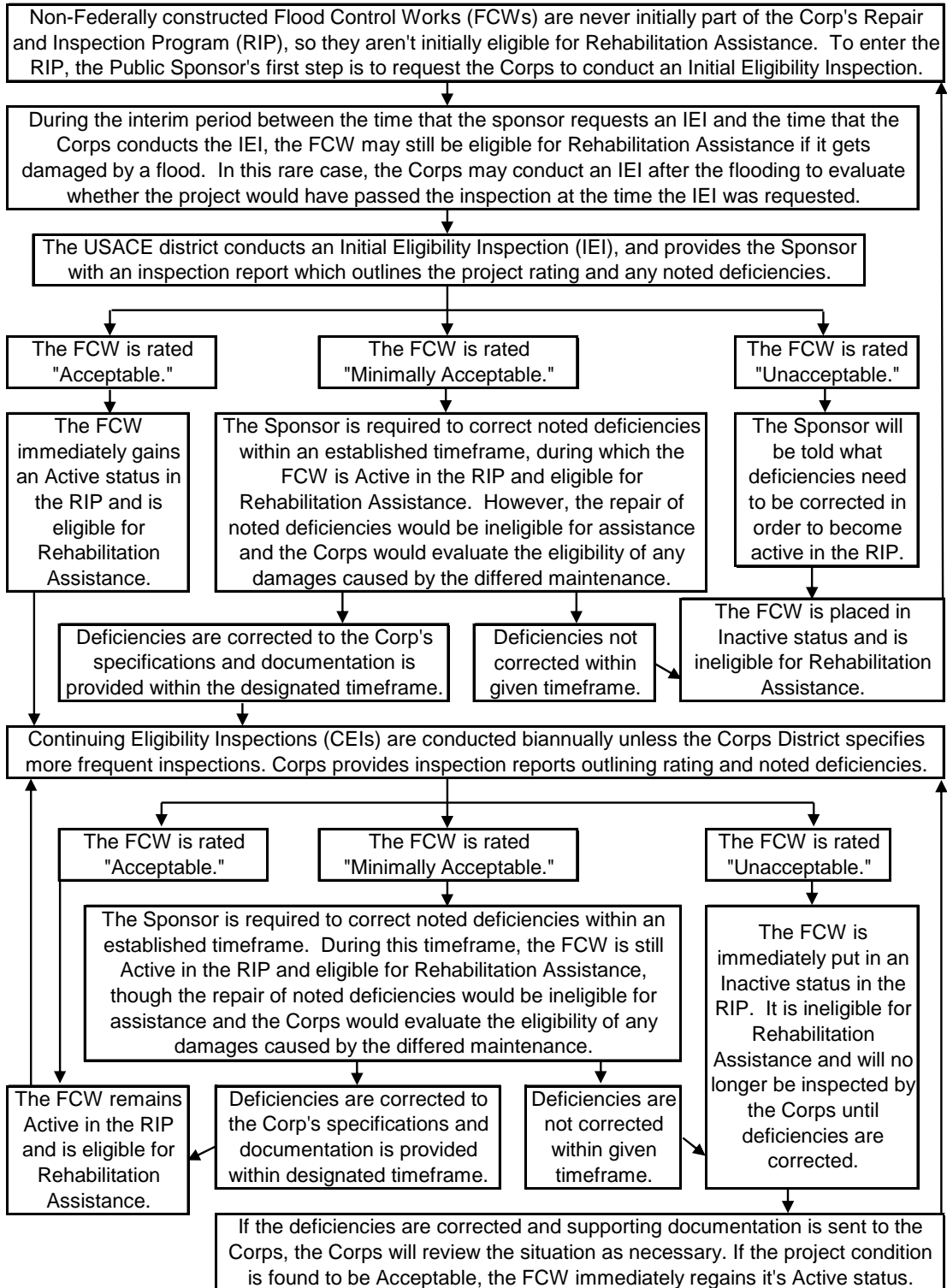
**Urban areas.** Cities, towns, or other incorporated or unincorporated political subdivisions of States that provide general local government for specific population concentrations, and occupy an essentially continuous area of developed land containing such structures as residences, public and commercial buildings, and industrial sites.

**Urban Levee.** A levee providing greater than a 10-year level of flood protection to a predominantly urban area.

**Work-in-Kind.** That portion of a public sponsor's cost share to rehabilitate a non-federal FCW that is a non-cash contribution. The work-in-kind may be in the form of labor, equipment, supplies, and/or services. Labor is defined as blue collar-type of work normally paid on an hourly wage basis, comparable to federal Wage Grade positions.

This page intentionally left blank.

## APPENDIX B: Flowchart of RIP Eligibility and Inspection Processes for Non-Federal FCW



This page intentionally left blank.

# APPENDIX C: FCW INSPECTION GUIDE

## U.S. Army Corps of Engineers Inspection Guide for Flood Control Works

<p>Name of Project: _____</p> <p>Date Inspected: _____</p> <p>Public Sponsor: _____</p> <p>Sponsor Phone/ Email: _____</p> <p>Corps of Engineers Inspector: _____</p> <p>Public Sponsor Representative: _____</p>	<p style="text-align: center;">Overall Project Rating (Check One):</p> <p> <input type="checkbox"/> Acceptable  <input type="checkbox"/> Minimally Acceptable (Maintenance is required)  <input type="checkbox"/> Unacceptable         </p>
<p>Type of Inspection (Check One):</p> <p> <input type="checkbox"/> Initial  <input type="checkbox"/> Continuing         </p>	<p style="text-align: center;">Overall Project Rating (Check One):</p> <p> <input type="checkbox"/> Acceptable  <input type="checkbox"/> Minimally Acceptable (Maintenance is required)  <input type="checkbox"/> Unacceptable         </p>
<p><b>INSPECTOR'S OBSERVATIONS:</b></p>	
<p><b>Contents of this Inspection Report:</b></p> <p> <input type="checkbox"/> Basic Eligibility (IEI specific)  <input type="checkbox"/> FCW Engineering (IEI specific)  <input checked="" type="checkbox"/> General Items for All Flood Control Works  <input type="checkbox"/> Levees  <input type="checkbox"/> Concrete Floodwalls  <input type="checkbox"/> Interior Drainage System  <input type="checkbox"/> Pump Stations  <input type="checkbox"/> Earthen Flood Control Channels  <input type="checkbox"/> Concrete Lined Channels  <input checked="" type="checkbox"/> Instructions         </p> <p>Note: A plan view drawing of the Flood Control Works, with stationing, should be attached to this report to reference locations of items rated less than acceptable. Photos should be taken of general project condition and any noted deficiencies.</p>	

**Basic Eligibility**  
 For use only during Initial Eligibility Inspections of Non-Federally Constructed Flood Control Works

RATED ITEM	A	M	U	N/A	EVALUATION	LOCATIONS/REMARKS/RECOMMENDATIONS
1. Public Sponsor (A or U only)					<p><b>A</b> The Public Sponsor is a legally constituted public body with full authority and capability to perform the terms of its agreement as the non-Federal partner of the Corps for a project, able to pay damages, if necessary, in the event of its failure to perform. The public sponsor may be a State, County, City, Town, Federally recognized Indian Tribe or tribal organization, Alaska Native Corporation, or any political subpart of a State or group of states that has the legal and financial authority and capability to provide the necessary cash contributions and the lands, easements, rights-of-way, relocations, and borrow and dredged or excavated materials disposal areas (LERRD's) necessary for the project, and who could legally hold and save the Federal government free from damages that could potentially arise during post-flood rehabilitations or other work on the FCW.</p> <p><b>U</b> The project does not have a public sponsor as defined above.</p>	
2. Flood Protection (A or U only)					<p><b>A</b> The principal function of the project is to protect people or property from floods.</p> <p><b>U</b> The project was built or is primarily used for channel alignment, recreation, fish and wildlife, land reclamation, drainage, to protect against land erosion or tidal inflows, or for some other non-flood related purpose.</p> <p><b>A</b> Project construction has been completed.</p> <p><b>U</b> The project is still under construction.</p>	
3. Project Completion (A or U only)					<p><b>A</b> Appropriate local, State, tribal, and/or Federal permits (right-of-way, easements, regulatory permits, etc.) or waivers thereof, have been obtained for FCW construction and subsequent modifications. The project was constructed in accordance with all applicable Federal, state and local codes, ordinances, and applicable laws.</p> <p><b>U</b> The appropriate permits (or waivers thereof) have not been obtained for the project, or the project was not constructed in accordance with applicable codes, ordinances, and laws.</p>	

Key: **A** = Acceptable, **M** = Minimally Acceptable; Maintenance is required, **U** = Unacceptable, **N/A** = Not Applicable, **RODI** = Requires Operation During Inspection



## FCW Engineering

For use only during Initial Eligibility Inspections of Non-Federally Constructed Flood Control Works

RATED ITEM	A			M			U			N/A			EVALUATION	LOCATIONS/REMARKS/RECOMMENDATIONS
1. Minimum Elevation (A or U only) (See instructions)													<p><b>A</b></p> <ul style="list-style-type: none"> <li>• <b>Urban Levees and Floodwalls</b>- Minimum elevation corresponding to a flood level with 10% probability of occurring in a given year (10-year flood).</li> <li>• <b>Agricultural Levees and Floodwalls</b>- Minimum elevation corresponding to a flood level with 20% probability of occurring in a given year (5-year flood).</li> <li>• <b>Flood Control Channels</b>- Minimum capacity is for a flood with a 10% probability of occurring in a given year (10-year flood). Improved channels must additionally provide drainage for at least 1.5 square miles of land and have a capacity of at least 800 cfs. (NOTE: Interior drainage channels within the protected area of a levee system are not flood control channels.)</li> </ul> <p><b>U</b> The FCW does not meet requirements for minimum elevation, capacity, or drainage area.</p>	
2. Physical Location and Cross Section (A or U only)													<p><b>A</b> The physical location, cross section, and other design elements of the FCW are sufficient to provide reliable flood protection. The FCW is (or is an element of) a closed system, tied into high ground.</p> <p><b>U</b> The FCW was not constructed in an appropriate location, does not have an appropriate cross section; is not properly tied into high ground, or has other shortcomings with design elements necessary for providing reliable flood protection.</p>	
3. Embankment Fill													<p><b>A</b> Embankment material is suitable to prevent slides and seepage problems.</p> <p><b>U</b> Embankment material is unsuitable and is likely to contribute to the development of slides or seepage problems.</p>	
4. Embankment Material Uniformity/Compactness													<p><b>A</b> Fill material is uniform and adequately compacted throughout the entire FCW.</p> <p><b>M</b> Fill material is uniform and adequately compacted in 75% or more of the FCW.</p> <p><b>U</b> Fill material is not uniform, or there is no compaction and evidence indicates a need for compaction.</p>	
													<p><b>A</b> Foundation material will not cause piping, sand boils, seepage, or settlements that will reduce the level of protection.</p> <p><b>M</b> Foundation material may show signs of excessive seepage, minor sand boils, and localized settlement.</p> <p><b>U</b> Foundation materials are unsuitable and likely to cause excessive uncontrolled seepage, sand boils, and / or piping.</p>	
													<p><b>N/A</b> The foundation problems described above do not apply to this type of FCW.</p>	
6. Primary Levee													<p><b>A</b> In the case of a levee project, the levee is a primary levee or is a secondary levee which is designed to protect human life or was designed as a major component of the primary levee system, necessary to assure the flood control protection of the total system.</p> <p><b>U</b> The levee is a secondary levee, and was not designed to protect human life or as a major component of the primary levee system.</p>	
													<p><b>N/A</b> The FCW is not a levee system.</p>	

Key: **A** = Acceptable, **M** = Minimally Acceptable, Maintenance is required, **U** = Unacceptable, **N/A** = Not Applicable, **RODDI** = Requires Operation During Inspection

**FCW Engineering (continued)**

For use only during Initial Eligibility Inspections of Non-Federally Constructed Flood Control Works

RATED ITEM	A			M			U			N/A			EVALUATION	LOCATIONS/ REMARKS/ RECOMMENDATIONS
7. Interior Drainage System (including culverts, gates, pump stations)													A Given the level of protection provided by the FCW, interior drainage structures are appropriately sized, situated, and constructed to move anticipated runoff and seepage out of the protected area. Pump stations will not become inundated during regular operation and their power system is adequately designed and reliable.	
													U Interior drainage structures are undersized, poorly constructed, poorly situated, or unreliably designed.	
													N/A The issue of interior drainage does not apply to this type of FCW.	
8. Structures													A Structures are capable of performing their designed functions and show no signs of failure.	
													M Structures are performing their design functions but show signs of overtopping and bypassing flows.	
													U Structures are not performing their designed functions or show signs of potential structural failure.	
9. Erosion Control													A Erosion protection is capable of handling the designed flow velocity for the level of protection for the entire FCW. The FCW is protected against bank caving and slides in all necessary areas, and has adequate drainage to protect FCW slopes from runoff erosion.	
													M Erosion protection is capable of handling the designed flow velocity for the level of protection for 75% or more of the FCW.	
													U Erosion protection measures protect less than 75% of the FCW. Erosion protection is not present and there is evidence indicating a need for erosion protection.	

Key: A = Acceptable. M = Minimally Acceptable; Maintenance is required. U = Unacceptable. N/A = Not Applicable. **RODI** = Requires Operation During Inspection

### General Items for All Flood Control Works

For use during Initial and Continuing Eligibility Inspections of all Flood Control Works

RATED ITEM	A			M			U			N/A			EVALUATION	LOCATIONS/ REMARKS / RECOMMENDATIONS
1. Project Operations and Maintenance Manual (A or U only)													A Levee Owner's Manual, ICW O&M Manuals, and/or manufacturer's operating instructions are present.	
													U These manuals are lost or missing.	
2. Emergency Supplies and Equipment													A The sponsor maintains a stockpile of sandbags, shovels, and other flood fight supplies which will adequately supply all needs for the initial days of a flood fight.	
													M The sponsor does not maintain an adequate supply of flood fighting materials as part of their preparedness activities.	
3. Flood Preparedness and Training (A or M only)													A Sponsor has a solid understanding of how to operate, maintain, and staff the FCW during a flood, and has written plans that include information such as low spots or sand boils. The sponsor also has plans that cover short term situations. (For instance, if a culvert through the levee is being replaced, then the sponsor knows how to respond to a flood while the levee integrity is lacking due to the construction.)	
													M The sponsor maintains a good working knowledge of flood response activities, but there are insufficient plans to address project specific features or short term situations, or the knowledge of flood response activities is maintained by a very small number of individuals within the community. Additional planning or training is required to ensure the success of the FCW during a flood event.	

Key: A = Acceptable. M = Minimally Acceptable; Maintenance is required. U = Unacceptable. N/A = Not Applicable. R/DI = Requires Operation During Inspection

**Levees**  
 For use during all Initial and Continuing Eligibility Inspections of levees

RATED ITEM	EVALUATION				LOCATIONS/ REMARKS / RECOMMENDATIONS
	A	M	U	N/A	
1. Sod Cover					
				<p><b>A</b> There is good coverage of sod cover over the levee.</p> <p><b>M</b> Approximately 25% of the sod cover is missing or damaged over a significant portion or over significant portions of the levee embankment. This may be the result of over-grazing or feeding on the levee, unauthorized vehicular traffic, chemical or insect problems, or burning during inappropriate seasons.</p> <p><b>U</b> Over 50% of the sod cover is missing or damaged over a significant portion or over significant portions of the levee embankment. This may be the result of over-grazing or feeding on the levee, unauthorized vehicular traffic, chemical or insect problems, or burning during inappropriate seasons.</p>	
				<p><b>A</b> The levee has a good grass cover with little or no unwanted vegetation (trees; bushes, or undesirable weeds) and has been recently mowed. Except in those cases where a vegetation variance has been granted by the Corps, a 5 meter (15') zone, free from all woody vegetation, is maintained adjacent to the landward/ riverside toe of the FCW for maintenance and flood-fighting activities. Additionally, a 1 meter (3') root free zone is maintained to protect the external limits of the levee cross section. Reference EM 1110-2-301 and/or local Corps policy.</p> <p><b>M</b> Minimal number of trees (5 cm (2") diameter or smaller) and/or brush present on the levee or within the 5 meter (15') zone, that will not threaten the integrity of the project but which need to be removed.</p> <p><b>U</b> Tree, weed, and brush cover exists in the FCW requiring removal to reestablish or ascertain FCW integrity. (NOTE: If significant growth on levees exists, prohibiting the inspection of animal burrows or other inspection items, then the levee inspection should be ended until this item is corrected.)</p>	
3. Depressions/ Rutting					
				<p><b>A</b> There are no ruts, pot holes, or other depressions on the levee, except for minor depressions caused by levee settlement. The levee crown, embankments, and access road crowns are well established and drain properly without any ponded water.</p> <p><b>M</b> Some minor depressions in the levee crown, embankment, or access roads that will not pond water and do not threaten the integrity of the levee.</p> <p><b>U</b> There are depressions greater than 15 cm (6 inches) deep that will pond water, endangering the integrity of the levee.</p>	
				<p><b>A</b> No active erosion or bank caving observed on the landward or on the riverward side of the levee.</p> <p><b>M</b> There are areas where active erosion is occurring or has occurred on or near the levee embankment, but levee integrity is not threatened.</p> <p><b>U</b> Erosion or caving is occurring or has occurred that threatens the stability and integrity of the levee. The erosion or caving has progressed into the levee section or into the extended footprint of the levee foundation and has compromised the levee foundation stability.</p>	
4. Erosion/ Bank Caving					
				<p><b>A</b> No active erosion or bank caving observed on the landward or on the riverward side of the levee.</p> <p><b>M</b> There are areas where active erosion is occurring or has occurred on or near the levee embankment, but levee integrity is not threatened.</p> <p><b>U</b> Erosion or caving is occurring or has occurred that threatens the stability and integrity of the levee. The erosion or caving has progressed into the levee section or into the extended footprint of the levee foundation and has compromised the levee foundation stability.</p>	
				<p><b>A</b> No active erosion or bank caving observed on the landward or on the riverward side of the levee.</p> <p><b>M</b> There are areas where active erosion is occurring or has occurred on or near the levee embankment, but levee integrity is not threatened.</p> <p><b>U</b> Erosion or caving is occurring or has occurred that threatens the stability and integrity of the levee. The erosion or caving has progressed into the levee section or into the extended footprint of the levee foundation and has compromised the levee foundation stability.</p>	

Key: **A** = Acceptable. **M** = Minimally Acceptable; Maintenance is required. **U** = Unacceptable. **N/A** = Not Applicable. **RODI** = Requires Operation During Inspection

**Levees (continued)**  
 For use during all Initial and Continuing Eligibility Inspections of levees

RATED ITEM	A			M			U			N/A			EVALUATION	LOCATIONS/ REMARKS / RECOMMENDATIONS
	A	M	U	A	M	U	A	M	U	A	M	U		
5. Slope Stability													A No slides present.	
													M Minor superficial sliding that with deferred repairs will not pose an immediate threat to FCW integrity.	
													U Evidence of deep seated sliding that threatens FCW integrity. Repairs are required to reestablish FCW integrity.	
6. Cracking													A No cracking observed on the levee greater than 15 cm (6 inches) deep.	
													M Longitudinal and/or transverse cracking greater than 15 cm (6 inches) deep. No evidence of vertical movement along the crack.	
													U Longitudinal and/or transverse cracking present and exhibits signs of vertical movement.	
7. Animal Control													A Continuous animal burrow control program in place that includes the elimination of active burrowing and the filling in of existing burrows.	
													M The existing animal burrow control program needs to be improved. Several animal burrows present which may lead to seepage or slope stability problems, and they require immediate attention.	
													U Animal burrow control program is not effective or is nonexistent. Significant maintenance is required to fill existing burrows, and the levee will not provide reliable flood protection until this maintenance is complete.	
8. Encroachments													A No trash, debris, excavations, structures, or other obstructions present within the project easement area. Encroachments which do not diminish proper functioning of the project have been previously approved by the Corps.	
													M Trash, debris, excavations, structures, or other obstructions present, or inappropriate activities that will not inhibit project operations and maintenance or emergency operations. Encroachments have not been approved by the Corps.	
													U Trash, debris, excavation, structures, or other obstructions present, or inappropriate activities that will inhibit project operations and maintenance or emergency operations.	
9. Riprap Revetments & Banks													A Existing riprap protection is properly maintained and is undamaged. Riprap clearly visible.	
													M No riprap displacement or scouring activity that could undercut banks, erode embankments, or restrict desired flow. Unwanted vegetation must be cleared and sprayed with an appropriate herbicide.	
													U Dense brush, trees, or grasses hide the rock protection, or meandering and/or scour activity is undercutting banks, eroding embankments, or impairing channel flows by causing turbulence or shoaling.	
													N/A There is no riprap protecting the levee.	

Key: A = Acceptable. M = Minimally Acceptable; Maintenance is required. U = Unacceptable. N/A = Not Applicable. **RODI** = Requires Operation During Inspection

Levees - Continued on Next Page

**Levees (continued)**

For use during all Initial and Continuing Eligibility Inspections of levees

RATED ITEM	A			M			U			N/A			EVALUATION	LOCATIONS/ REMARKS/ RECOMMENDATIONS
10. Closure Structures (Stop Log, Earthen Closures, or Gates) (A or U only)												A Closure structure in good repair. Placing equipment, stoplogs, and other materials are readily available at all times. Components of closure clearly marked and installation instructions / procedures readily available.		
												U Closure structure in poor condition. Parts missing or corroded. Placing equipment may not be available within normal warning time.		
11. Underseepage Relief Wells/ Toe Drainage Systems												N/A There are no closure structures along the levee.		
												A Toe drainage systems and pressure relief wells necessary for maintaining FCW stability during flood events functioned properly during the last flood event and no sediment is observed in horizontal system (if applicable). Nothing is observed which would indicate that the system won't function properly during the next flood.		
												M Toe drainage systems or pressure relief wells are damaged and may become clogged if they are not repaired.		
												U Toe drainage systems or pressure relief wells necessary for maintaining FCW stability during flood events have fallen into disrepair or have become clogged.		
												N/A There are no relief wells/ toe drainage systems along the levee.		

Key: A = Acceptable. M = Minimally Acceptable; Maintenance is required. U = Unacceptable. N/A = Not Applicable. **RODI** = Requires Operation During Inspection

*Additional issues noted during the inspection:*

### Concrete Floodwalls

For use during all Initial and Continuing Eligibility Inspections of concrete floodwalls

RATED ITEM	EVALUATION				LOCATIONS/ REMARKS / RECOMMENDATIONS
	A	M	U	N/A	
1. Concrete Surfaces					<p><b>A</b> Negligible spalling, scaling or cracking. If the concrete surface is weathered, rough to the touch, or holds moisture, it is still satisfactory but should be seal coated to prevent freeze/ thaw damage.</p> <p><b>M</b> Spalling, scaling, and open cracking present, but the immediate integrity or performance of the structure is not threatened. Reinforcing steel may be exposed. Repairs/ sealing is necessary to prevent additional damage during periods of thawing and freezing.</p> <p><b>U</b> Surface deterioration or deep, controlled cracks present that result in an unreliable structure.</p>
2. Tilting, Sliding or Settlement of Concrete and Sheet Pile Structures					<p><b>A</b> There are no significant areas of tilting, sliding, or settlement that would endanger the integrity of the project.</p> <p><b>M</b> There are areas of tilting, sliding, or settlement (either active or inactive) that need to be repaired. The integrity of the structure is not in danger.</p> <p><b>U</b> There are areas of tilting, sliding, or settlement (either active or inactive) that threaten the structure's integrity and performance.</p>
3. Foundation of Concrete and Sheet Pile Structures					<p><b>A</b> No scouring / erosion, or undermining near the structure.</p> <p><b>M</b> Scouring / erosion near the footing of the structure but not close enough to affect structure stability during the next flood.</p> <p><b>U</b> Scouring or undermining at the foundation that has affected structural integrity.</p>
4. Monolith Joints					<p><b>A</b> The monolith joint material is in good condition.</p> <p><b>M</b> The monolith joint material is deteriorating and needs to be repaired or replaced to prevent spalling and cracking during freeze/ thaw cycles.</p> <p><b>U</b> The monolith joint material is severely deteriorated and the concrete has spalled and cracked, damaging the waterstop to the point where it will not provide the intended level of protection during a flood.</p> <p><b>N/A</b> There are no monolith joints in the floodwall.</p>
5. Erosion/ Bank Caving					<p><b>A</b> No active erosion or bank caving on the riverward side of the floodwall which might endanger its stability.</p> <p><b>M</b> There are areas where the ground is eroding towards the base of the floodwall and efforts need to be taken to slow and repair this erosion, but the erosion has not yet progressed to the point that the floodwall will lose stability during a flood event.</p> <p><b>U</b> Erosion or bank caving is occurring or has occurred riverward of the levee which threatens the stability of the floodwall.</p>

Key: **A** = Acceptable, **M** = Minimally Acceptable; Maintenance is required, **U** = Unacceptable, **N/A** = Not Applicable, **RODI** = Requires Operation During Inspection

Concrete Floodwalls- Continued on the next page

### Concrete Floodwalls (continued)

For use during all Initial and Continuing Eligibility Inspections of concrete floodwalls

RATED ITEM	A			M			U			N/A			EVALUATION	LOCATIONS/ REMARKS/ RECOMMENDATIONS
6. Unwanted Vegetation Growth													A A grass-only zone is maintained on both sides the floodwall. All trees, brush, and unwanted vegetation have been removed from this zone for maintenance, flood-fighting activities, and to protect the floodwall. The grass-only zone extends from the concrete wall to a point 2.5 meters (8') beyond the underground toe and heel of the floodwall. Reference EM 1110-2-30 and/or local Corps policy.	
													M There are some areas where unwanted vegetation is growing near the floodwall. This vegetation must be removed, but does not currently threaten the integrity of the project.	
													U There is a significant amount of tree, weed, or brush growth near the floodwall, which may limit access during flood fight operations or the roots of which may offer accelerated seepage paths under the structure.	
7. Encroachments													A No trash, debris, excavations, structures, or other obstructions present within the project easement area. Encroachments which do not diminish proper functioning of the project have been previously approved by the Corps.	
													M Trash, debris, excavations, structures, or other obstructions present, or inappropriate activities that will not inhibit project operations and maintenance or emergency operations. Encroachments have not been approved by the Corps.	
													U Trash, debris, excavation, structures, or other obstructions present, or inappropriate activities that will inhibit project operations and maintenance or emergency operations.	
8. Closure Structures (Stop Log Closures and Gates) (A or U only)													A Closure structure in good repair. Placing equipment, stoplogs, and other materials are readily available at all times. Components of closure clearly marked and installation instructions / procedures readily available.	
													U Closure structure in poor condition. Parts missing or corroded. Placing equipment may not be available within normal warning time.	
													N/A There are no closure structures along the floodwall.	
9. Underseepage Relief Wells/ Toe Drainage Systems													A Toe drainage systems and pressure relief wells necessary for maintaining FCW stability during flood events functioned properly during the last flood event and no sediment is observed in horizontal system (if applicable). Nothing is observed which would indicate that the system won't function properly during the next flood.	
													M Toe drainage systems or pressure relief wells are damaged and may become clogged if they are not repaired.	
													U Toe drainage systems or pressure relief wells necessary for maintaining FCW stability during flood events have fallen into disrepair or have become clogged.	
													N/A There are no relief wells/ toe drainage systems along the floodwall.	

Key: A = Acceptable, M = Minimally Acceptable; Maintenance is required, U = Unacceptable, N/A = Not Applicable, R/D/I = Requires Operation During Inspection

Additional issues noted during the inspection:



### Interior Drainage System

For use during all Initial and Continuing Eligibility Inspections of systems carrying interior drainage through the FCW

RATED ITEM	A			M			U			N/A			EVALUATION	LOCATIONS/ REMARKS/ RECOMMENDATIONS
1. Vegetation and Obstructions													A Minimal, scattered obstructions or vegetation. The flow is not impeded.	
													M Log jams, snags, vegetation growth (such as cat tails, bull rushes, bushes, or saplings), or other obstructions block approximately 25% of the FCW.	
													U Log jams, snags, vegetation growth (such as cat tails, bull rushes, bushes, or saplings), or other obstructions block approximately 50% of the FCW.	
2. Encroachments													A No trash, debris, excavations, structures, or other obstructions present within the project easement area. Encroachments which do not diminish proper functioning of the project have been previously approved by the Corps.	
													M Trash, debris, excavations, structures, or other obstructions present, or inappropriate activities that will not inhibit project operations and maintenance or emergency operations. Encroachments have not been approved by the Corps.	
													U Trash, debris, excavation, structures, or other obstructions present, or inappropriate activities that will inhibit project operations and maintenance or emergency operations.	
3. Riprap Revetments of Inlet/ Discharge Areas													A Existing riprap protection is properly maintained and is undamaged. Riprap clearly visible.	
													M No riprap displacement or scouring activity that could undercut banks, erode embankments, or restrict desired flow. Unwanted vegetation must be cleared and sprayed with an appropriate herbicide.	
													U Dense brush, trees, or grasses hide the rock protection, or meandering and/or scour activity is undercutting banks, eroding embankments, or impairing channel flows by causing turbulence or shoaling.	
													N/A There is no riprap protecting the interior drainage system, or the riprap is discussed in another section.	
4. Erosion of Inlet/ Discharge Areas													A No active erosion or bank caving observed on the landward or on the riverward side of the levee.	
													M There are areas where active erosion is occurring or has occurred on or near the levee embankment, but levee integrity is not threatened.	
													U Erosion or caving is occurring or has occurred that threatens the stability and integrity of the levee. The erosion or caving has progressed into the levee section or into the extended footprint of the levee foundation and has compromised the levee foundation stability.	
													N/A There are no inlet/discharge areas.	

Key: A = Acceptable. M = Minimally Acceptable; Maintenance is required. U = Unacceptable. N/A = Not Applicable. **RODI** = Requires Operation During Inspection

### Interior Drainage System (continued)

For use during all Initial and Continuing Eligibility Inspections of systems carrying interior drainage through the FCW

RATED ITEM	A			M			U			N/A			EVALUATION	LOCATIONS/ REMARKS / RECOMMENDATIONS
5. Blockage of Culverts (Inlets, Sump, and Discharge Areas)													A There is little or no debris, sediment, or vegetation blocking the culverts, inlets, sump, or discharge areas. The channel capacity for designed flow is not affected.	
													M Debris, sediment, or vegetation blocks less than 10 percent of the culvert opening, but must be removed.	
													U Accumulated debris, sediment, or vegetation blocks more than 10 percent of the culvert opening, impairing the culvert's capacity and hydraulic effectiveness.	
													N/A There are no culverts.	
6. Culverts													A There are no breaks, holes, cracks in the culvert that would result in significant water leakage. Corrugated metal pipes, if present, are in good condition or have been relined with appropriate material, which is still in good condition.	
													M There are breaks, holes, cracks in the culvert that would result in water leakage and need to be repaired, but do not threaten the integrity of the project. Corrugated metal pipes, if present, are showing deterioration but the entire length of pipe is still structurally sound and is not in danger of collapsing.	
													U Culvert has deterioration and/or has significant leakage such that it threatens the integrity of the FCW. Corrugated metal pipes are in danger of collapsing or have already begun to collapse.	
													N/A There are no culverts.	
8. Trash Racks (non-mechanical)													A Trash racks are fastened in place and properly maintained.	
													M Trash racks are in place but are unfastened or have bent bars that allow debris to enter into the pipe or pump station. Repair or replacement is required.	
													U Trash rack is missing or damaged to the extent that it is no longer functional and must be replaced.	
9. Flap Gates/Flap Valves/ Pinch Valves RODI													N/A There are no trash racks.	
													A Flap gates open and close easily with minimal leakage. Gates show no corrosion damage and have been maintained.	
													M Gate will not fully open or close because of obstructions that can be easily removed, or has corrosion damage that requires maintenance.	
													U Gate is missing, has been damaged, or has deteriorated and needs repair.	
												N/A There are no flap gates.		

Key: A = Acceptable; M = Minimally Acceptable; Maintenance is required; U = Unacceptable; N/A = Not Applicable; RODI = Requires Operation During Inspection

Interior Drainage - Continued on Next Page

### Interior Drainage System (continued)

For use during all Initial and Continuing Eligibility Inspections of systems carrying interior drainage through the FCW

RATED ITEM	A			M			U			N/A			EVALUATION	LOCATIONS/ REMARKS / RECOMMENDATIONS
10. Sluice / Slide Gates RODI													A Gates open and close freely with minor leakage. Sill is free of sediment and other obstructions. Gates and lifters have been maintained.	
													M Gates have been damaged or have deteriorated, and open and close with resistance or binding. Leakage quantity is controllable and is not a threat to project performance. Maintenance is required.	
													U Gates do not open or close. Gate, stem, lifter and/or guides may be damaged or corroded.	
11. Electric Gate Operators for Sluice / Slide Gates RODI													N/A There are no sluice/ slide gates.	
													A All electric gate operators are in good working condition and are adequately powered, and are capable of opening and closing the gate properly. Preventative maintenance is being performed and the system is tested periodically.	
													M All electric gate operators are operational with minor deficiencies, but should perform through the next period of usage.	
12. Manual Operators (Backups) for Sluice / Slide Gates RODI													U The electric gate operators are not operational, or the power source is not considered reliable to sustain operations during flood conditions.	
													N/A There are no electric gate operators.	
													A All manual gate operators are in good working condition and are capable of opening and closing the gate properly. Preventative maintenance is being performed and the system is tested periodically.	
13. Concrete Surfaces (Such as gate wells, outfalls, intakes, or culverts)													M Manual gate operators are operational with minor deficiencies, but should perform through the next period of usage.	
													U Manual gate operators are not operational.	
													N/A If there are sluice or slide gates, there needs to be means of operating them manually. If there are no sluice/slide gates, this item is N/A.	
													A Negligible spalling, scaling or cracking. If the concrete surface is weathered, rough to the touch, or holds moisture, it is still satisfactory but should be seal coated to prevent freeze/ thaw damage.	
													M Spalling, scaling, and open cracking present, but the immediate integrity or performance of the structure is not threatened. Reinforcing steel may be exposed. Repairs/ sealing is necessary to prevent additional damage during periods of thawing and freezing.	
													U Surface deterioration or deep, controlled cracks present that result in an unreliable structure.	
													N/A There are no concrete surfaces.	

Key: A = Acceptable. M = Minimally Acceptable; Maintenance is required. U = Unacceptable. N/A = Not Applicable. **RODI** = Requires Operation During Inspection

Interior Drainage - Continued on Next Page

### Interior Drainage System (continued)

For use during all Initial and Continuing Eligibility Inspections of systems carrying interior drainage through the FCW

RATED ITEM	A			M			U			N/A			EVALUATION	LOCATIONS/ REMARKS / RECOMMENDATIONS
14. Tilting, Sliding or Settlement of Concrete and Sheet Pile Structures (Such as gate wells, outfalls, intakes, or culverts)													A There are no significant areas of tilting, sliding, or settlement that would endanger the integrity of the project.	
													M There are areas of tilting, sliding, or settlement (either active or inactive) that need to be repaired. The integrity of the structure is not in danger.	
													U There are areas of tilting, sliding, or settlement (either active or inactive) that threaten the structure's integrity and performance.	
													N/A There are no concrete structures.	
15. Foundation of Concrete Structures (Such as gate wells, outfalls, or culverts)													A No scouring / erosion, or undermining near the structure.	
													M Scouring / erosion near the footing of the structure but not close enough to affect structure stability during the next flood.	
													U Scouring or undermining at the foundation that has affected structural integrity.	
													N/A There are no concrete structures.	
16. Safety Fencing RODI													A Safety/ security fencing is in good condition and provides protection against falling or unauthorized access. Gates open and close freely, locks are in place, and there is little corrosion on metal parts.	
													M Safety/ security fencing or gates are damaged or corroded but appear to be maintainable. Locks may be missing or damaged.	
													U Safety/ security fencing and gates are damaged or corroded to the point that replacement is required, or potentially dangerous project features are not secured.	
													N/A There are no features of the internal drainage system that require safety fencing.	
17. Other Metallic Items													A All metal parts are protected from corrosion damage, and show no rust, damage, or deterioration that would cause a safety concern.	
													M Corrosion seen on metallic parts appear to be maintainable.	
													U Metallic parts are severely corroded and require replacement to prevent failure, equipment damage, or safety issues.	
													N/A There are no other significant metallic items associated with the interior drainage system.	

Key: A = Acceptable. M = Minimally Acceptable; Maintenance is required. U = Unacceptable. N/A = Not Applicable. RODI = Requires Operation During Inspection

Additional issues noted during the inspection:

**Pump Stations**  
For use during all Initial and Continuing Eligibility Inspections of pump stations

RATED ITEM	A			M			U			N/A			EVALUATION	LOCATIONS/ REMARKS / RECOMMENDATIONS
1. Pump Stations Operating Log (A or U only)													A Operation and maintenance log is present at the pump station and is being used and updated, and personnel have been trained in pump station operations. Names and last training date shown in the log book.	
													U No operating log present, or refresher training for personnel has not been conducted.	
2. Pump Station Operations and Maintenance Manual (A or U only)													A Operation and Maintenance Manual and/or posted operating instructions are present and adequately cover all pertinent pump station features.	
													U Operation and Maintenance Manual missing or sponsor is unsure of location.	
3. Plant Building													A The building is in good structural condition, with no major cracks in concrete or brick. The roof is not leaking, exhaust fans are operational, there are no exposed electrical components, and the working environment is safe.	
													M There is significant cracking in the building structure, or the building is damaged in other ways such that it needs repair but does not threaten pumping operations.	
													U The structural integrity or stability of the building is threatened, or there is other damage to the building such that pumping operations can not be performed as intended.	
													A A telephone, cellular phone, two-way radio, or similar device is available to pump station operator and maintenance personnel.	
4. Communications (A or U only)													U A telephone, cellular phone, two-way radio, or similar device is <u>not</u> available to pump station operator and maintenance personnel.	
													A Exhaust fans, vents/louvers are working properly. Fuel storage / distribution meets state / local requirements. Fire extinguishers of sufficient quality, quantity, and type are on hand and are properly charged. Safety hardware (hand rails, grates for wet-wells, etc) is installed. Required safety items used (hearing, eyes, etc).	
5. Safety (A or U only)													U Safety issues exist that could cause injury or loss of life.	
													A Safety/ security fencing is in good condition and provides protection against falling or unauthorized access. Gates open and close freely, locks are in place, and there is little corrosion on metal parts.	
6. Safety Fencing RODI													M Safety/ security fencing or gates are damaged or corroded but appear to be maintainable. Locks may be missing or damaged.	
													U Safety/ security fencing and gates are damaged or corroded to the point that replacement is required, or potentially dangerous project features are not secured.	
													N/A There are no features in or around the pump stations that require safety fencing.	

Key: A = Acceptable, M = Minimally Acceptable, Maintenance is required, U = Unacceptable, N/A = Not Applicable, RODI = Requires Operation During Inspection

Pump Stations - Continued on Next Page

**Pump Stations (continued)**  
 For use during all Initial and Continuing Eligibility Inspections of pump stations

RATED ITEM	A			M			U			N/A			EVALUATION	LOCATIONS/ REMARKS / RECOMMENDATIONS
7. Cranes RODI													A Crane operational, and have been inspected and load tested in accordance with OSHA requirements.	
													M Crane has not been inspected or operationally tested with the past year, or there are visible signs of corrosion, oil leakage, etc, requiring maintenance.	
													U Crane not operational, or tagged out of service.	
													N/A There are no cranes.	
8. Pumps													A All pumps are properly maintained and lubricated. Systems are periodically tested, and there is no evidence of cavitation, vibrations, or unusual sounds.	
													M Minor deficiencies exist which need to be closely monitored or repaired, such as the presence of minor vibrations or the corrosion of the pump shaft housing. However, the pumps are operational and are expected to perform through the next period of usage.	
													U One or more of the pumps are not operational, or the pump capacity has degraded to the point where project performance is in question.	
9. Power (A or U only)													A The power source is adequate, safe, and reliable. Backup generators are on hand or there is a reliable backup power plan in place. Backup units are properly sized, operational, periodically exercised, and properly maintained.	
													U Power source not considered safe or reliable to sustain operations during flood conditions.	
10. Insulation Megger Testing													A Results of megger tests show that the insulation meets manufacturer's or industry standards. Tested within the last 2 years.	
													M Results of megger test show that insulation resistance is lower than manufacturer's or industry standard, but can be corrected with proper application of heat, or megger testing not conducted with the last 2 years.	
													U Megger tests not conducted within past three years or indicate that insulation resistance is low enough that the equipment will not be able to meet design standards of operation; or evidence of arcing or shorting is detected visually.	
11. Motors, Engines, Fans and Gear Reducers													A All items are operational. Preventative maintenance and lubrication is being performed and the system is periodically subjected to performance testing. Instrumentation, alarms, and auto shutdowns are operational.	
													M Systems have minor deficiencies, but are operational and will function adequately through the next flood.	
													U One or more of the primary motors or systems is not operational.	

Key: A = Acceptable. M = Minimally Acceptable; Maintenance is required. U = Unacceptable. N/A = Not Applicable. **RODI** = Requires Operation During Inspection

Pump Stations - Continued on Next Page

**Pump Stations (continued)**  
 For use during all Initial and Continuing Eligibility Inspections of pump stations

RATED ITEM	A			M			U			N/A			EVALUATION	LOCATIONS/ REMARKS/ RECOMMENDATIONS
12. Pump Control Systems													A Operational and maintained free of damage, corrosion, or other debris.	
													M Operational with minor discrepancies. Will function adequately during the next flood event.	
													U Pump controls not operational. May not function adequately during the next flood event.	
13. Sumps / Wet well													A Clear of excessive debris, sediment, or other obstructions. Procedures are in place to remove debris accumulation during operation.	
													M Debris, sediment, or other obstructions are present and must be removed, but the sump/ wet well will function as intended during the next flood. Procedures are in place to remove debris accumulation during operation.	
													U Large debris or excessive silt present which will hinder or damage pumps during operation, or no procedures have been established to remove debris accumulation during operation.	
14. Trash Rakes (Mechanical Operations) RODI													A Drive chain, bearing, gear reducers, and other components are in good operating condition and are being properly maintained.	
													M The trash rake is in need of maintenance, but is still operational.	
													U Trash rake not operational or deficiencies will inhibit operations during the next flood event.	
15. Trash Racks (non-mechanical)													N/A There are no mechanical trash rakes.	
													A Trash racks are fastened in place and properly maintained.	
													M Trash racks are in place but are unfastened or have bent bars that allow debris to enter into the pipe or pump station. Repair or replacement is required.	
16. Sluice / Slide Gates RODI													U Trash rack is missing or damaged to the extent that it is no longer functional and must be replaced.	
													N/A There are no non-mechanical trash rakes.	
													A Gates open and close freely with minor leakage. Sill is free of sediment and other obstructions. Gates and lifters have been maintained.	
													M Gates have been damaged or have deteriorated, and open and close with resistance or binding. Leakage quantity is controllable and is not a threat to project performance. Maintenance is required.	
													U Gates do not open or close. Gate, stem, lifter and/or guides may be damaged or corroded.	
													N/A There are no sluice/slide gates.	

Key: A = Acceptable. M = Minimally Acceptable; Maintenance is required. U = Unacceptable. N/A = Not Applicable. **RODI** = Requires Operation During Inspection

**Pump Stations (continued)**  
 For use during all Initial and Continuing Eligibility Inspections of pump stations

RATED ITEM	A			M			U			N/A			EVALUATION	LOCATIONS/ REMARKS / RECOMMENDATIONS
17. Electric Gate Operators for Sluice / Slide Gates (Intake/ Discharge) RODI													A All electric gate operators are in good working condition and are adequately powered, and are capable of opening and closing the gate properly. Preventative maintenance is being performed and the system is tested periodically.	
													M All electric gate operators are operational with minor deficiencies, but should perform through the next period of usage.	
													U The electric gate operators are not operational, or the power source is not considered reliable to sustain operations during flood conditions.	
18. Manual Operators (Backups) for Sluice / Slide Gates RODI													N/A There are no electric gate operators.	
													A All manual gate operators are in good working condition and are capable of opening and closing the gate properly. Preventative maintenance is being performed and the system is tested periodically.	
													M Manual gate operators are operational with minor deficiencies, but should perform through the next period of usage.	
19. Other Metallic Items (Equipment, Ladders, Platform Anchors, etc)													U Manual gate operators are not operational.	
													N/A If there are sluice or slide gates, there needs to be means of operating them manually. If there are no sluice/slide gates, this item is N/A.	
													A All metal parts are protected from corrosion damage, and show no rust, damage, or deterioration that would cause a safety concern.	
													M Corrosion seen on metallic parts appear to be maintainable.	
													U Metallic parts are severely corroded and require replacement to prevent failure, equipment damage, or safety issues.	
													N/A There are no other significant metallic items associated with the pump stations.	

Key: A = Acceptable. M = Minimally Acceptable; Maintenance is required. U = Unacceptable. N/A = Not Applicable. **RODI** = Requires Operator During Inspection

*Additional issues noted during the inspection:*



### Earthen (Excavated) Flood Control Channels

For use during all Initial and Continuing Eligibility Inspections of excavated flood control channels

RATED ITEM	A			M			U			N/A			EVALUATION	LOCATIONS/ REMARKS / RECOMMENDATIONS
1. Vegetation and Obstructions													A There are minimal obstructions or vegetation blocking the FCW.	
													M The channel is obstructed by minor log jams, snags, or vegetation. Less than 20% of the channel is obstructed.	
													U Obstructions or vegetation growth have obstructed over 20% of the river or channel.	
2. Shoaling													A No shoaling present.	
													M Non-aquatic grasses present on shoal. No trees or brush is present on shoal, and channel flow is not impeded.	
													U Shoaling is well established, stabilized by trees, brush, or other vegetation. Shoals are diverting flow to channel bank causing bank erosion and undercutting.	
3. Encroachments													A No trash, debris, excavations, structures, or other obstructions present within the project easement area. Encroachments which do not diminish proper functioning of the project have been previously approved by the Corps.	
													M Trash, debris, excavations, structures, or other obstructions present, or inappropriate activities that will not inhibit project operations and maintenance or emergency operations. Encroachments have not been approved by the Corps.	
													U Trash, debris, excavation, structures, or other obstructions present, or inappropriate activities that will inhibit project operations and maintenance or emergency operations.	
4. Riprap Revetments & Banks													A Existing riprap protection is properly maintained and is undamaged. Riprap clearly visible.	
													M No riprap displacement or scouring activity that could undercut banks, erode embankments, or restrict desired flow. Unwanted vegetation must be cleared and sprayed with an appropriate herbicide.	
													U Dense brush, trees, or grasses hide the rock protection, or meandering and/or scour activity is undercutting banks, eroding embankments, or impairing channel flows by causing turbulence or shoaling.	
5. Erosion													N/A There is no riprap protecting the channel.	
													A No head cutting or horizontal deviation observed.	
													M Head cutting and horizontal deviation evident, but is less than 30 cm (1 foot) from the designed grade or cross section.	
													U Apparent head cutting and horizontal deviation of more than 30 cm (1 foot) from the designed grade or cross section. Corrective actions required to stop or slow erosion.	

Key: A = Acceptable. M = Minimally Acceptable; Maintenance is required. U = Unacceptable. N/A = Not Applicable. **RODI** = Requires Operation During Inspection

Earthen Flood Control Channels - Continued on Next Page

### Earthen (Excavated) Flood Control Channels (continued)

For use during all Initial and Continuing Eligibility Inspections of excavated flood control channels

RATED ITEM	EVALUATION			LOCATIONS/ REMARKS / RECOMMENDATIONS
	A	M	U	
6. Concrete Surfaces				<b>A</b> Negligible spalling, scaling or cracking. If the concrete surface is weathered, rough to the touch, or holds moisture, it is still satisfactory but should be seal coated to prevent freeze/ thaw damage.
				<b>M</b> Spalling, scaling, and open cracking present, but the immediate integrity or performance of the structure is not threatened. Reinforcing steel may be exposed. Repairs/ sealing is necessary to prevent additional damage during periods of thawing and freezing.
				<b>U</b> Surface deterioration or deep, controlled cracks present that result in an unreliable structure.
				<b>N/A</b> There are no concrete structures associated with the flood control channel.
7. Tilting, Sliding or Settlement of Concrete Structures				<b>A</b> There are no significant areas of tilting, sliding, or settlement that would endanger the integrity of the project.
				<b>M</b> There are areas of tilting, sliding, or settlement (either active or inactive) that need to be repaired. The integrity of the structure is not in danger.
				<b>U</b> There are areas of tilting, sliding, or settlement (either active or inactive) that threaten the structure's integrity and performance.
				<b>N/A</b> There are no concrete structures associated with the flood control channel.
8. Foundation of Concrete Structures				<b>A</b> No scouring / erosion, or undermining near the structure.
				<b>M</b> Scouring / erosion near the footing of the structure but not close enough to affect structure stability during the next flood.
				<b>U</b> Scouring or undermining at the foundation that has affected structural integrity.
				<b>N/A</b> There are no concrete structures associated with the flood control channel.
9. Flap Gates/Flap Valves/ Pinch Valves RODI				<b>A</b> Flap gates open and close easily with minimal leakage.
				<b>M</b> Gate will not fully open or close because of obstructions that can be easily removed, or has corrosion damage that requires maintenance.
				<b>U</b> Gate is missing, has been damaged, or has deteriorated and needs repair.
				<b>N/A</b> There are no flap gates.

Key: **A** = Acceptable, **M** = Minimally Acceptable; Maintenance is required, **U** = Unacceptable, **N/A** = Not Applicable, **RODI** = Requires Operation During Inspection

*Additional issues noted during the inspection:*

### Concrete Lined Flood Control Channels

For use during all Initial and Continuing Eligibility Inspections of concrete lined flood control channels

RATED ITEM	A			M			U			N/A			EVALUATION	LOCATIONS/ REMARKS / RECOMMENDATIONS
1. Vegetation and Obstructions													A No obstructions, vegetation, debris, or sediment accumulation within the channel. Channel joints and weep holes are also free of grass and weeds.	
													M Sediment and debris present, but not to the degree that it supports vegetation. Obstructions/ debris have not impaired the channel flow capacity. Sediment and debris removal recommended.	
													U Sediment shoals are well established and support vegetation, or there are obstructions or accumulated debris that have impaired the channel flow capacity. Sediment and debris removal required to re-establish flow capacity.	
2. Shoaling													A No shoaling present.	
													M Non-aquatic grasses present on shoal. No trees or brush is present on shoal, and channel flow is not impeded.	
													U Shoaling is well established, stabilized by saplings, brush, or other vegetation. Shoals are diverting flow to channel walls. Channel flow capacity is reduced and maintenance is required.	
3. Concrete Surfaces													A Negligible spalling, scaling or cracking. If the concrete surface is weathered, rough to the touch, or holds moisture, it is still satisfactory but should be seal coated to prevent freeze/ thaw damage.	
													M Spalling, scaling, and open cracking present, but the immediate integrity or performance of the structure is not threatened. Reinforcing steel may be exposed. Repairs/ sealing is necessary to prevent additional damage during periods of thawing and freezing.	
													U Surface deterioration or deep, controlled cracks present that result in an unreliable structure.	
4. Tilting, Sliding or Settlement of Concrete Structures													A There are no significant areas of tilting, sliding, or settlement that would endanger the integrity of the project.	
													M There are areas of tilting, sliding, or settlement (either active or inactive) that need to be repaired. The integrity of the structure is not in danger.	
													U There are areas of tilting, sliding, or settlement (either active or inactive) that threaten the structure's integrity and performance.	
5. Foundation of Concrete Structures													A No scouring / erosion, or undermining near the structure.	
													M Scouring / erosion near the footing of the structure but not close enough to affect structure stability during the next flood.	
													U Scouring or undermining at the foundation that has affected structural integrity.	

Key: A = Acceptable, M = Minimally Acceptable; Maintenance is required, U = Unacceptable. N/A = Not Applicable. **RODI** = Requires Operation During Inspection

Concrete Lined Channels - Continued on Next Page

### Concrete Lined Flood Control Channels

For use during all Initial and Continuing Eligibility Inspections of concrete lined flood control channels

RATED ITEM	A			M			U			N/A			EVALUATION	LOCATIONS/ REMARKS/ RECOMMENDATIONS
6. Monolith Joints													<p><b>A</b> The monolith joint material is in good condition.</p> <p><b>M</b> The monolith joint material is deteriorating and needs to be repaired or replaced to prevent spalling and cracking during freeze/ thaw cycles.</p> <p><b>U</b> The monolith joint material is severely deteriorated and the concrete has spalled and cracked, damaging the waterstop to the point where it will not provide the intended level of protection during a flood.</p> <p><b>N/A</b> There are no monolith joints.</p>	
7. Flap Gates/Flap Valves/ Pinch Valves RODI													<p><b>A</b> Flap gates open and close easily with minimal leakage.</p> <p>Gates show no corrosion damage and have been maintained.</p> <p><b>M</b> Gate will not fully open or close because of obstructions that can be easily removed, or has corrosion damage that requires maintenance.</p> <p><b>U</b> Gate is missing, has been damaged, or has deteriorated and needs repair.</p> <p><b>N/A</b> There are no flap gates.</p>	

Key: **A** = Acceptable, **M** = Minimally Acceptable; Maintenance is required, **U** = Unacceptable, **N/A** = Not Applicable, **RODI** = Requires Operation During Inspection

*Additional issues noted during the inspection:*

## Instructions for the Inspection Guide

### GENERAL INSTRUCTIONS.

1. The sections of this report labeled "Basic Eligibility" and "FCW Engineering" only need to be completed during Initial Eligibility Inspections.
2. Determination of Minimum Elevation for Levees and Floodwalls (#1 under FCW Engineering):  
Depending on available data and local Corps policy, the minimum elevation required may be calculated using traditional methods, with the addition of 1 foot of freeboard in agricultural areas and 2 feet of freeboard in urban areas, or using annual exceedance probability, which numerically accounts for the natural variation and uncertainty when estimating discharge-probability and stage-discharge functions so that additional requirements for elevation are based on the level of risk in the data.
3. All other sections of this guide that correspond to project features in the Flood Control Work must be fully completed during every Continuing and Initial Eligibility Inspection.
4. RODI stands for "Requires Operation During Inspection". Items marked "RODI" will be rated based on the way they work during the inspection.
5. Additional areas for inspection will be incorporated by the inspector into this guide if the layout or physical characteristics of the project warrant this. Appropriate entries will be made in the REMARKS block.

---

### RATINGS OF INDIVIDUAL ITEMS:

The following terms and definitions are used when determining the rating for each item and/or component in the flood control work.

- A - Acceptable:** The rated item is in satisfactory condition, with no deficiencies, and will function as designed and intended during the next flood event.
- M - Minimally Acceptable:** This rated item has minor deficiencies that need to be corrected. The minor deficiencies will not seriously impair the functioning of the item during the next flood event. The overall reliability of the project will be lowered because of the minor deficiency.
- U - Unacceptable:** The deficiencies are serious enough that the rated item will not adequately function during the next flood event, compromising the project's ability to provide reliable flood protection.

---

### DETERMINATION OF OVERALL PROJECT CONDITION CODE:

The lowest single rating given for a rated item will determine the overall condition of the project:

1. If all items are rated as Acceptable, the overall project condition will be rated as Acceptable.
2. If one or more items are rated as Minimally Acceptable, the overall project condition will be rated Minimally Acceptable.
3. If one or more items are rated as Unacceptable, the overall project condition will be rated as Unacceptable.

---

### PROJECT CONDITION AND ELIGIBILITY FOR PL84-99 ASSISTANCE:

1. Projects rated as Acceptable are considered "**Active**" and eligible for PL84-99 post flood or storm damage rehabilitation assistance from the U.S. Army Corps of Engineers.
2. Projects rated Minimally Acceptable are considered "**Active**" and eligible for PL84-99 rehabilitation assistance during the time that it takes to make needed corrections. This timeframe will be agreed upon between the project sponsor and Corps inspector at the time of the inspection (or shortly thereafter). If the project sponsor does not present the Corps with proof of completion of the repairs/maintenance by the end of this timeframe, then the project will be "**Inactive**" and will be ineligible for PL84-99 rehabilitation assistance.
3. Projects rated as Unacceptable are immediately put in an "**Inactive**" status and are not eligible for PL84-99 post flood or storm damage rehabilitation assistance from the Corps of Engineers. The project will remain in an inactive status until the project sponsor presents the Corps with proof that all of the required repairs/maintenance has been completed. (This includes any repairs/ maintenance required for project features rated minimally Acceptable, as well as those rated Unacceptable.)

This page intentionally left blank.

# APPENDIX D: Flood Fighting Techniques on Levees

## Appendix D Contents

<b>1.</b>	<b>INTRODUCTION .....</b>	<b>2</b>
<b>2.</b>	<b>OVERTOPPING.....</b>	<b>3</b>
2.1	Options for Raising a Levee .....	3
2.2	Raising a Levee with Earthen Fill.....	5
2.3	Raising a Levee with Sandbags .....	9
2.4	Raising the levee with Flashboards or Lumber and Sack Cappings.....	14
<b>3.</b>	<b>SEEPAGE.....</b>	<b>15</b>
3.1	Effects of Underseepage .....	15
3.2	Sandboils.....	16
3.3	Sloughs.....	19
3.4	Floating Soil Conditions .....	20
3.5	Other Seepage Related Considerations.....	20
<b>4.</b>	<b>EROSION .....</b>	<b>21</b>
4.1	Wave Wash.....	21
4.2	Scours.....	23
4.3	Ice and Floating Debris.....	24

## Plates

- Plate 1: Emergency Earth Capping
- Plate 2: Sand Bag Capping
- Plate 3: Lumber and Sack Capping
- Plate 4: Method of Draining Levee Slope
- Plate 5: Sack Revetment
- Plate 6: Polyethylene Levee Protection
- Plate 7: Placement of Polyethylene Sheeting in the Wet
- Plate 8: Emergency Wave Wash Protection
- Plate 9: Movable Wave Wash Protection
- Plate 10: Deflection Weir, Type A
- Plate 11: Deflection Weir, Type B
- Plate 12: Emergency Crevasse Closure
- Plate 13: Plank Road
- Plate 14: Plank Runway
- Plate 15: Miscellaneous Details

# 1. Introduction

If a well-constructed levee of correct cross section is properly maintained and is not overtopped, it should hold throughout any major flood event. However, the levee is still in potential danger whenever there is water against it. The danger increases with the height of water, the duration of the flood stage, the intensity of the current, and the wave action against the levee face. There are three primary factors that lead to levee failures.

1. Overtopping
2. Seepage problems such as sandboils or slides
3. Erosion from the current or waves

Potential levee failures may be prevented if prompt action is taken and proper methods of treatment are employed. This appendix describes some of the general actions that should be taken to raise the crown of a levee or to respond to sandboils, seepage problems, or wave wash if these problems are identified during a patrol. The methods described have been developed from many years of experience in dealing with problems that arise as a result of high water, and should be followed as closely as possible. (The intent of this isn't to destroy personal initiative when dealing with unusual emergencies. On the contrary, if a dangerous situation occurs along a levee line, immediate action is demanded using the materials and labor at hand. However, an emergency is not a time in which to experiment, and these proven methods should be employed wherever possible.) Conditions and problems may arise which are not adequately covered by the suggestions provided or if there's any doubt as to the proper procedure that should be taken, the local U.S. Army Corps of Engineers district Emergency Management Office should immediately be consulted for advice and assistance.



## 2. Overtopping

A levee is overtopped when water flows over the levee crown. Low reaches in the levee crown must be identified as early as possible and raised to a uniform level. If the stream is predicted to approach or exceed the height of the existing levee, immediate attention should be given to raising the levee crown.

On the other hand, if the stream is likely to crest many feet beyond the elevation of the levee, the best approach may be to simply allow the levee to overtop, so that flood fight efforts can be redirected to other areas. If this is the case, low reaches in the levee crown need to be raised, leveled or otherwise prepared so that it overtops uniformly, to keep the damage to a minimum. Ideally, the levee should be allowed to overtop uniformly along the downstream portion of the system, so the protected area is "backfilled" with flood water. If the levee is breached due to the overtopping along the downstream portion of the FCW, it prevents the full force of the river's current from flowing into the protected area. An upstream breach will allow the river current to bring in much more debris (for example, entire trees), and would possibly cause much more scouring damage to the protected area than a downstream overtopping breach. It's very important that you contact the Corps district office when faced with decisions relating to the overtopping of a levee, as the Corps has a great deal of experience with flood fighting and can provide technical assistance and guidance as needed.

Generally, emergency barriers are constructed 2 feet above the current predicted river crest. For example, if the river is predicted to rise 1 1/2 feet beyond the elevation of the levee, then a 3 1/2 foot capping would be necessary in order to maintain two feet of freeboard as a factor of safety. If the crest prediction increases during construction, additional height must be added.

### 2.1 Options for Raising a Levee

There are a number of ways that the levee crown can be raised. Provided the work is done well in advance of the high water, in areas where there is sufficient space for construction and with the proper equipment, the most efficient means of raising low stretches of the levee is to scarify the surface, haul in fill material and compact it in place, as discussed in section 2.2, below. However, this is not always possible. No heavy equipment should be used on a levee when water is near the top, as the vibration may cause a failure. In no case should such equipment be allowed on an earthen levee after the levee has commenced to seep. For these reasons, raising the elevation with compacted earthen fill may not be an option. The levee crown may alternately be raised with a sandbag capping or with flashboard structures. Jersey barriers have also successfully been converted into floodwalls during emergency situations.

Additionally, there are a large number of contemporary technologies that may be used to raise an emergency levee; including bladders, structurally supported membranes, and lightweight shells that are filled with sand from a bucket loader. The Corps' Engineer Research and Development Center has recently completed a rigorous and impartial study on several of these flood fight technologies. You are encouraged to visit <http://chl.erd.c.usace.army.mil/ffs> for details on the tests and products, since this site will have the Corps' most current information on the subject, and the website will be updated as additional products are tested.

With so many options available for raising a flood barrier, there are several things you should consider as you decide how to best protect your community:

**a. Cost of materials and labor**

The materials for sandbag construction are generally much less expensive than the alternatives. Sandbag construction is very labor intensive, but at the same time, volunteer labor is often readily available during high water.

**b. Available time**

Flashboards or contemporary options are better suited to conditions when there is little time available for the construction, because they typically require less labor and can be put in place much faster than sandbag levees.

**c. Allowable seepage**

Most construction methods will allow some degree of seepage through the structure. As is the case with sandbags, modifications may be made to the basic designs so that the seepage is reduced, but these modifications usually take additional time to construct.

**d. Suitability for construction in the given area**

Sandbags are extremely versatile and sandbag structures can be constructed almost anywhere. Sandbags can be used to close small roads or to fill gaps, or can be built into long stretches of levees if there is adequate time and manpower. Flashboards and newer technologies are generally not as versatile, but depending on the technology and the construction, they are typically well suited for raising the elevation over longer stretches.

**e. Equipment requirements**

Sandbag structures can be built without heavy machinery, which may be required for some other options. There are a number of situations where it's not possible to use even light earthmoving machinery. For example, there might not be enough space for the machinery, or the foundations might be too unstable. Also, individual landowners may object to the use of machinery over their properties.

**f. Necessary elevation**

Though sandbag levees are best suited for elevations of 3 feet or less, they have successfully been used to raise elevations by 20 feet or more in extreme flooding situations. Flashboards are typically only built to a maximum of 3 feet, and the elevation provided by other technologies varies. In deciding between the various options, it's important to consider how reliably they can forecast the crest height of the river. If the river stage might rise several feet beyond what is currently predicted, a sandbag levee could be raised higher, while it would be much more difficult to raise something like a flashboard or Jersey barrier structure.

**g. Disposal**

Burlap sandbags are biodegradable and relatively easy to remove and dispose of. Other options typically take much longer to remove and create more waste. Some are reusable.

Situations may arise when one of the more contemporary products may be readily available and appropriate for the given conditions, when there would be insufficient workers available to protect the area with sandbags or when time was extremely limited; and in these situations the cost of using these products may be justified. While it would be prohibitively expensive for the Corps to stockpile enough inventories to adequately address all problems that might be faced across the country, the Corps may purchase such items and make them available for public sponsors if conditions warrant. However, in the majority of situations, sandbags are almost always preferred and recommended during flood fights when construction with earthen fill is not possible. The following sections provide specific guidance on raising levees using earthen fill, sandbags, and flashboards.

**2.2 Raising a Levee with Earthen Fill**

**a. Borrow Area and Haul Road**

Borrow material can become a critical item of supply in some areas due to long haul, project isolation, or for other reasons. The two prime requisites for a borrow area are that adequate material be available and that the site be accessible at all times. The quantity estimate plus an additional 50 percent should provide the basis for the area requirement, in order to provide suitable materials for levee construction as covered below. The area must be located so that it will not become isolated from the project by high water. Local contractors and local officials are the best source of information on available borrow areas. In undeveloped areas, the area should be cleared of brush, trees, and debris, with topsoil and humus being stripped. In early spring, it will probably be necessary to rip the area to remove frozen material. An effort should be made to borrow from the area in such a manner that the area will be relatively smooth and free draining when the operation is complete. The haul road may be an existing road or street, or it may have to be constructed. To mitigate damages, it is highly desirable to use unpaved trails and roads, or to construct a road if the haul distance is short. In any case, the road should be maintained to avoid unnecessary traffic delays. The use of flagmen and warning signs is mandatory at major crossings, such as highways, near schools, and at major pedestrian crossings. It may become necessary to stockpile material near anticipated trouble areas.

**b. Equipment**

One of the important considerations in earthwork construction is the selection of proper equipment to do the work. Under emergency conditions, obtaining normally specified earthwork equipment will be difficult and the work will generally be done with locally available equipment. It may be wise to call for technical assistance in the early contract stage to ensure that proper and efficient equipment use is proposed. If possible, compaction equipment should be used in flood barrier construction. This may

involve sheepsfoot, rubber-tired, or vibratory rollers. Scrapers should be used for hauling when possible because of speed (on short haul) and large capacity. Truck haul, however, has been the most widely used. A ripper is almost essential for opening borrow areas in the early spring. A bulldozer of some size is mandatory on the job to help spread dumped fill and provide some compaction.

### **c. Foundation preparation**

One of the primary differences in the construction of emergency levees and the construction of permanent levees lies in the preparation of the foundation. Prior to any embankment construction, it's very important that the foundation is prepared, particularly if the levee is to be left in place. For emergency construction during spring flooding, the first item of work will probably be snow removal. The snow should be pushed riverward so as to decrease ponding when it melts. Any trees that might be present should be cut and the stumps removed. If at all possible, any obstructions above the ground (brush or similar debris) should be removed. The foundation should then be stripped of topsoil and surface humus. (Clearing and grubbing, structure removal and stripping should be performed only if time permits.) Stripping may be impossible if the ground is frozen, and in this case, the foundation should be ripped or scarified, if possible, to provide a tough surface for the material to bond to. Every effort should be made to remove all ice or soil containing ice lenses. Frost or frozen ground can give a false sense of security in the early stages of a flood fight. It can act as a rigid boundary and support the levee, but when it thaws, the soil strength may be reduced sufficiently for cracking or the development of slides. The ice also forms an impervious barrier to prevent seepage. This may result in a considerable build-up in pressure under the soils landward of the levee and, upon thawing, pressure may be sufficient to cause sudden blowouts. If this condition exists, it must be monitored, and one must be prepared to act quickly if sliding or boiling starts. If stripping is possible, the material should be pushed landward and riverward of the toe of levee and windrowed. After the flood, this material can be spread on the slopes to provide topsoil for vegetation.

### **d. Materials**

Earth fill materials for emergency levees will come from local borrow areas. An attempt should be made to utilize materials which are compatible with the foundation materials as explained below. However, due to time limitation, any local materials may be used if reasonable construction procedures are followed. The materials should not contain large frozen pieces of earth.

#### **i. Clay**

Clay is preferred because the section can be made smaller (steeper side slopes). Also, clay is relatively impervious, and has relatively high resistance to erosion when it's compacted. A disadvantage in using clay is that adequate compaction is difficult to obtain without proper equipment. Additionally, the water content in impervious fill can impact the compaction needs. Efforts are typically made at the borrow site to obtain material with the optimal moisture; otherwise, if that is not

possible, more time may be required for compaction. Another disadvantage is that the clay may be wet and sub-freezing temperatures may cause the material to freeze in the borrow pit and in the hauling equipment. Weather could cause delays and should definitely be considered in the overall construction effort.

**ii. Sand**

If sand is used, the section should comply as closely as possible with recommendations in the paragraph titled Levee Section, below. Flat slopes are important, as steep slopes without poly coverage will cause seepage through the levee to outcrop high on the landward slope, and may cause the slope to slump.

**iii. Silt**

Material that is primarily silt should be avoided, and if it is used, poly facing must be applied to the river slope. Silt, upon wetting, tends to collapse under its own weight and is very susceptible to erosion.

**e. Levee Section**

In standard levees, the foundation soils and available construction materials generally dictate the design configuration of the levee. Therefore, even under emergency conditions, an attempt should be made to make the embankment compatible with the foundation. Information on foundation soils may be available from local officials or engineers, and it should be utilized. The three foundation conditions and the levee sections cited below are classical and idealized, and usual field conditions depart from them to various degrees. However, they should be used as a guide so that possible serious flood fight problems might be lessened during high water. In determining the top width of any type of section, consideration should be given as to whether a revised forecast will require additional fill to be placed. A top width adequate for construction equipment will facilitate raising the levee. Finally, actual levee construction will in cases, depend on time, materials, and right-of-way available.

**i. Sand Foundation**

If the foundation material under the emergency levee is sand or some other pervious material, the following guidance is provided:

- If the levee section is to be made of sand, use a minimum of 1V (Vertical) on 3H (Horizontal) river slopes. A 1V on 4H river slope is preferable, and will be less susceptible to erosion, but a 1V on 3H slope is considered an adequate minimum for emergency purposes. Use 1V on 5H for the landward slope, and 10-foot top width.
- If the levee section is to be made of clay, use 1V on 2 1/2 H for both slopes. 1V on 3H slopes are preferable, but 1V on 1 1/2 H is an acceptable minimum for emergency purposes. The bottom width should comply with creep ratio criteria; i.e., L (across bottom) should be equal to C x H; where C=9 for fine gravel and 15 for fine sand in the foundation, and H is levee height.

This criteria can be met by using berms either landward or riverward of the levee. Berm thickness should be 3 feet or greater. Berms are used mainly to control or to relieve uplift pressures and will not reduce seepage significantly.

## **ii. Clay Foundation**

If the foundation material under the emergency levee is clay, the following guidance is provided:

- If the levee section is to be made of sand, it should be constructed with 1V on 3H for the river slope. Again, a 1V on 4H is preferable, but the steeper slope is considered adequate for emergency purposes. Use 1V on 5H for the landward slope, and a 10-foot top width, as described in the previous section.
- If the levee section is to be made of clay, use 1V on 2 1/2 H for both slopes. 1V on 3H slopes are preferable for clay levees, but 1V on 1 1/2 H is an acceptable minimum for emergency purposes. With a clay foundation, there is no need to construct additional berms.

## **iii. Clay Layer over a Sand Foundation**

If the foundation material is such that there is an impervious clay layer resting over a pervious sand layer, the following guidance is provided:

- If the levee section is to be made of sand, use a minimum of 1V (Vertical) on 3H (Horizontal) river slopes for emergency purposes. A 1V on 4H slope is preferable, if this construction is possible. 1V on 5H landward slope, and 10-foot top width. In addition, a landside berm of sufficient thickness may be necessary to prevent rupture of the clay layer. The berm may be constructed of sand, gravel, or clay, but since berms made of clay generally need to be wider and thicker than those made of pervious materials, it would probably reduce the construction effort to build the berm with sand or gravel, if these materials were available. Standard design of berms requires considerable information and detailed analysis of soil conditions. However, prior technical assistance may reduce berm construction requirements in any emergency situation.
- If the levee section is to be made of clay, use 1 V on 2 1/2 H for both slopes. Again, 1V on 3H slopes are preferable, but 1V on 1 1/2 H is an acceptable minimum for emergency purposes. Additionally, a berm may be necessary to prevent rupture of the impervious top stratum.

## **f. Placement**

Layers should be started out to the full width of the embankment base, and subsequent lifts shall be placed so that the tops are substantially horizontal. In general, the levee

section should be homogeneous. However, when materials of varying permeability are encountered in the borrow area, the more pervious material should be placed on the landside of the embankment.

**g. Compaction**

As stated above, obtaining proper compaction equipment for a given soil type will be difficult. It is expected in most cases that the only compaction will be from that due to the hauling and spreading equipment, i.e., construction traffic routed over the fill. It is to be realized that even the minimum requirements may not be possible or feasible, and, if situation demands, material should be placed and compacted in any way possible and the levee observed closely for signs of distress. A construction engineer should ideally oversee the design of emergency levees. Use of these guidelines should not be taken as a guarantee that a safe structure will be constructed.

**i. Pervious Fill**

Material shall be placed in layers not more than 12 inches in thickness prior to compaction. In emergency situations, each layer should be compacted at the very minimum by one pass of the hauling equipment. However, whenever time, cost and availability of equipment will permit, a much safer structure will result if each layer gets compacted by a minimum of 3 complete passes of a crawler-type tractor, or by 2 passes of a vibratory roller.

**ii. Impervious Fill**

Fill material shall be placed in layers not exceeding 9 inches prior to compaction. In emergency situations, each layer should receive at least one complete coverage of the track or wheel of the placing equipment or equivalent. However, whenever time, cost and availability of equipment will permit, a much safer structure will result if each layer gets compacted by a minimum of 4-6 complete passes of a tamping type roller or 4 complete passes of a rubber-tired roller.

**2.3 Raising a Levee with Sandbags**

**a. Sandbags**

Sandbags are available in plastic and in burlap. The preferred bags are untreated, close weave burlap sacks available at feed or hardware stores. Empty bags should be stockpiled for emergency use, and can be stored for approximately 8 years in a rodent-free environment with low humidity. Don't fill the bags ahead of time, because they will deteriorate quickly. Commercial polypropylene sandbags are also effective in a flood fight, but since plastic bags are not readily biodegradable, burlap bags will allow more options for disposal if the bags are not going to be reused. (No sandbags should be left in place after the flood fight, regardless of whether they are burlap or plastic.) Do not use garbage bags, as they are too slick to stack; and don't use feed sacks, as they are too large to handle. Experience shows that bags work well if they are approximately 14 inches wide and 24 inches deep.

## b. Fill Material

A sandy soil is most desirable for filling sandbags, as it's easiest to shovel, and the bags can most easily be shaped as needed. Fine sand tends to leak through the weave in the bag, and if it is used it should be double bagged. Silty soils also tend to leak through the bags, and both silty soils and clays are difficult to shape into place. Gravelly or rocky soils are generally poor choices for sandbag structures because of their permeability, though rocks and gravel may be used in sandbags in order to divert water flows, to fill holes, or to hold objects in position. However, any usable material at or near the site has definite advantages. Material should generally not be removed from within 500 feet of the landward toe of a levee, except for in extreme emergency situations.

## c. Sandbag Filling

Filling sandbags manually requires two people. One member of the team folds the throat of the bag outward to form a collar, and holds it open so that the other person can shovel in material. The one holding the bag should hold it between or slightly in front of his or her feet, either crouching with his elbows resting on his knees or standing with his knees slightly flexed, while keeping his head and face as far away from the shovel as possible. Both people should be wearing gloves to protect their hands, and safety goggles may also be desirable, especially on dry or windy days.



*Figure D.1 This two-person team is positioned properly for sandbag filling.*

If they are available during large-scale operations, bag-holding racks and power loading equipment can expedite the operation. Sandbag filling machines can be very effective if they are functioning correctly. Alternately, some people have reported success with improvised sandbag filling devices during a flood response. Inverted traffic cones or large metal funnels have been placed into holes in a table, and feeding bins with doors in their bases have been used to pour sand into bags.

Regardless of what method you use to fill them, bags should be filled between one-half (1/2) to two-thirds (2/3) of their capacity. This keeps the bag from getting too heavy, but more importantly, sandbag structures do not seal or keep out water as well if the bags are more than 2/3 full. Be very careful not to overfill or under fill the bags.

## d. Tied vs. Untied Bags

Although tied sandbags are generally easier to handle and stockpile, untied sandbags are recommended for most situations, because untied bags make a better seal when they're stacked. Since the bags aren't more than 2/3 full, they can be transported almost as easily whether they're tied or untied. Tied sandbags should be used only for



special situations when the bags need to be pre-filled and stockpiled, or for specific purposes such as filling holes or for holding objects in position.

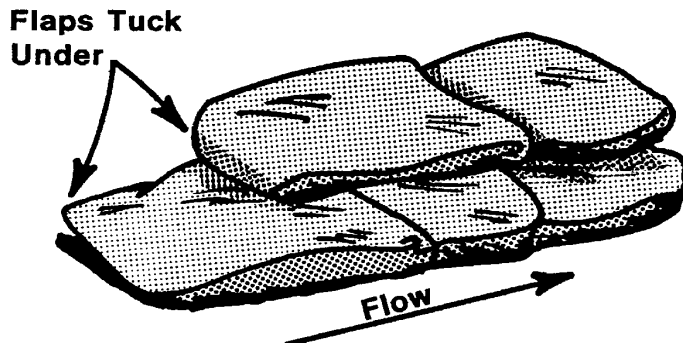
#### e. Preparing the Ground

Any debris must be removed from the area before the bags are laid in place. Typically, flat headed shovels are used to scrape up (“scarp”) the sod or gravel where they are to be laid, to get down to the solid ground where the bags are to be laid. Do not scarp the ground beyond the area directly under the sandbags, because the sod cover in other areas is needed to protect the ground from erosion.

Before laying the bags along the entire length of an area to raise the levee, it’s important that you first fill in any low areas with sandbags or with tightly packed earth, so that subsequent sandbag layers will be kept level.

#### f. Sandbag Placement

When laying the sandbags, the open end of the unfilled portion of the bag is folded over to form a triangle. If tied bags are used, flatten or flare the tied end. Place the partially filled bags lengthwise and parallel to the direction of flow, so the bottom of the bag faces downstream and the folded end faces upstream. (This positioning reduces the chance that floating debris will snag on the tucks and open the bags.)



*Figure D.2 Sandbag placement – tucking in the flaps.*

Tuck the flaps under, keeping the unfilled portion under the weight of the sack. Overlap the next bag slightly over the one before it, so that the top of that sandbag layer can be flattened without leaving any gaps between the bags. Once a bag is placed, it’s very important that you then walk over it, stomp on it, or maul it into place to eliminate voids and form a tight seal.

When succeeding layers are added, stagger the bags like bricks, so that each one is placed over the gap between the two below it. This ensures that each seam is interlocked between bags and strengthens the structure. (There should never be less than 1/3 the length of a bag overlapping with the ones beneath it.) When placed properly, each bag should raise the elevation of the structure by 4 inches.



*Place each succeeding bag tightly against and partially overlapping the previous one. Compact and shape each bag by walking on it.*

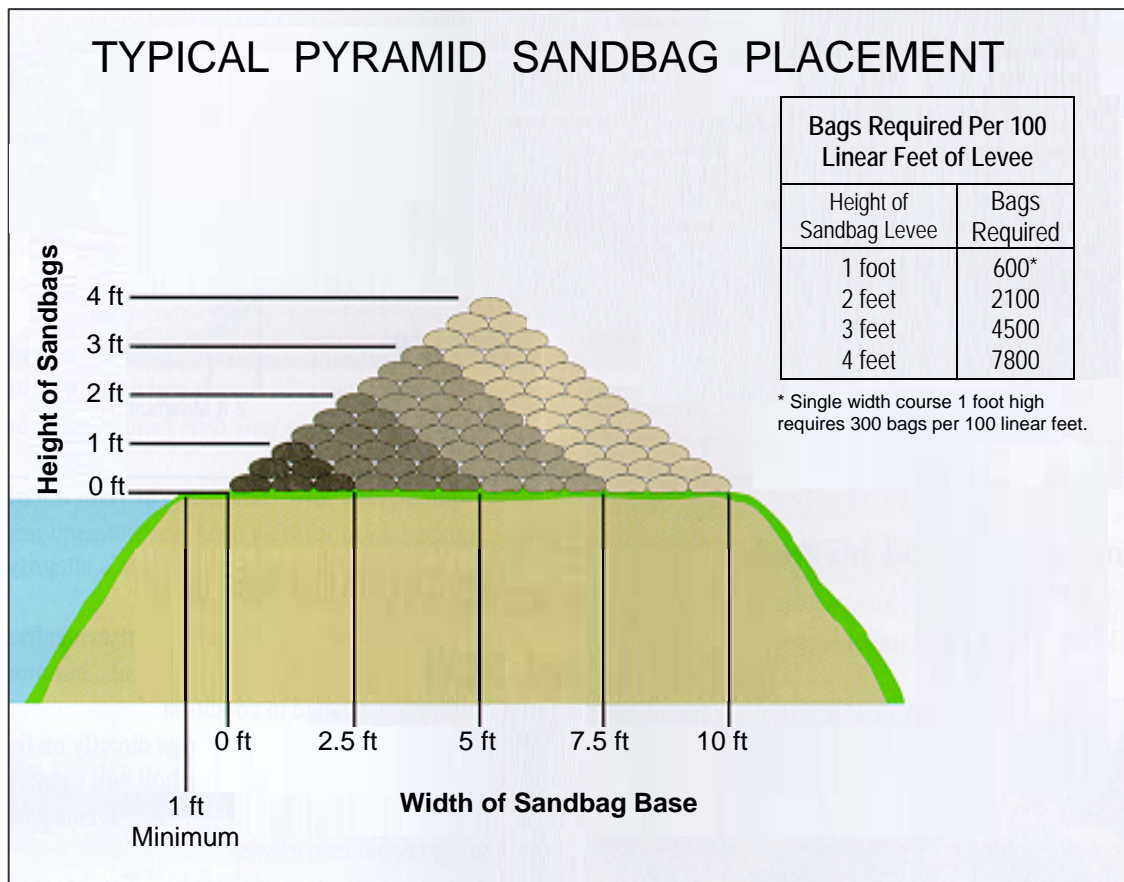
*Figure D.3 Sandbag placement – compacting bags together.*

**g. Sandbag Levees**

Sandbags can be used to raise the height of an existing levee or can be used over open ground to protect an area with no levee at all. Any time a sandbag levee will be constructed over one layer high; the bag should be stacked in a pyramid structure to ensure stability. The basic rules of thumb in constructing these structures is that they must be approximately three times as wide as they are high, and the sandbags should be staggered within each layers just as they are staggered from one layer to the next. The directions of the bags (transverse or longitudinal) may be alternated, as long as no loose ends are left exposed. Use this rule of thumb in determining the dimensions of the pyramid:

- 1 bag in length equals about 1 foot
- 3 bags in width equals about 2 ½ feet
- 3 bags in height equals about 1 foot

When building these structures on top of an existing levee, the bags should begin 1 foot from the riverward crown (shoulder) of the levee. Where space is extremely limited on the levee crown, this distance may be reduced but the structure should never be built less than 6 inches from the edge of the levee crown. Stamp each bag in place, overlap sacks, maintain staggered joint placement, and tuck in any loose ends.



*Figure D.4 Pyramid sandbag placement.*

**h. Material, Tools, and Labor Requirements for Sandbag Levee**

Listed below are the materials, tools, and labor required to construct 100 linear feet of sandbag levee, two feet high, with a haul distance of 1 mile round trip.

**i. Materials and Tools**

- 1,800 Sandbags
- 10 Shovels
- 27 Flash lights
- 10 Tons sand (approx)
- 2 Emergency light sets
- 2 Radios or cell phones (one at filling site; one at laying site)
- 6 Pickup trucks

**ii. Labor Requirements:**

- 10 Filling sandbags
- 5 Loading
- 6 Hauling
- 5 Laying
- 2 Foremen (1 at sandbag filling site, 1 at work site)
- 28 People required, total**

**iii. Time Requirements:**

With given resources, the time for completion is estimated at 2 ½ hours, from start to finish.

**i. Bonding Trench and Plastic Sheetting**

Seepage through a sandbag structure can be kept to a minimum if the structure is built carefully using untied bags. One method that's been successfully used to reduce the seepage through a sandbag levee and to increase the horizontal stability is to construct a bonding trench under the structure before the sandbags are laid in place, as pictured below. An additional precaution is to build the structure over some plastic sheetting, which is pulled up and over the structure once it's complete.

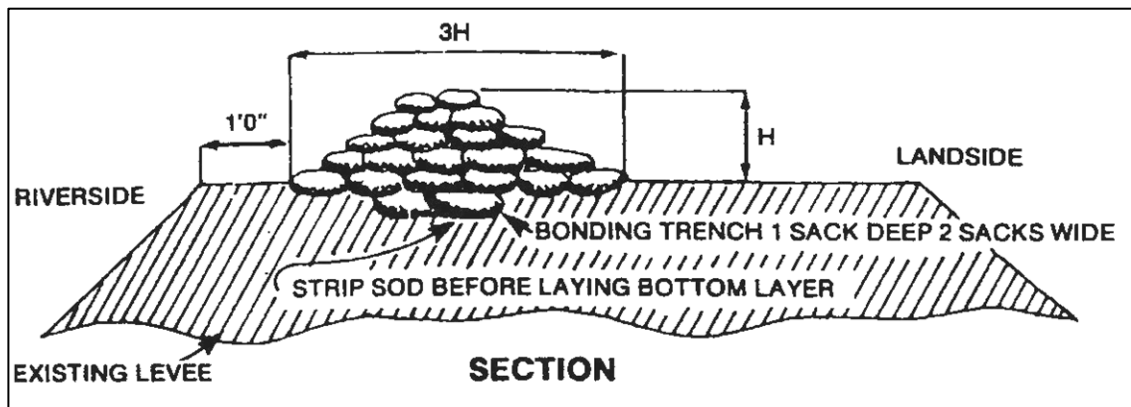


Figure D.5 Sketch of a typical levee raise with bonding trench.

While it's always recommended at least to scarp the ground before the bags are laid, the decision to dig this trench or use the plastic sheeting depends on local conditions, as well as on the expected height of the structure and the time that's available to build it. One of the primary concerns when considering bonding trenches and/or plastic sheeting is the amount of time that's available. If there's sufficient time and adequate material, the seepage can be reduced, but if there is very little time available, the ground should be scarped and a typical sandbag structure constructed with no bonding trench at all. An additional concern is whether the sandbag levee would have to be raised in the future, because any plastic sheeting has to be removed before the structure can be raised.

If plastic sheeting is to be used in conjunction with the sandbag levee, begin by digging a bonding trench 2 sandbags wide and one sandbag deep. The edge of the plastic is placed in the hole and weighed down with sandbags, with most of the plastic laying out in the direction of the river. It's very important that the plastic is never laid across the entire width of the sandbag levee base. Sandbag levees are held together by frictional forces between the bags and with the ground surface; sandbag structures are much less stable when wrapped with plastic, and can slide apart under high water. Construct the sandbag levee over the sheeting, pull the plastic up and overtop of the structure and weigh it down with sandbags on the landward side. Always work from downstream to upstream so that the upstream plastic seams all overlap the ones downstream, in order to prevent debris from snagging the plastic and pulling the sandbag levee apart.

#### **2.4 Raising the levee with Flashboards or Lumber and Sack Cappings**

If it appears that the levee raise would have to hold back more than 18 inches of water, consideration should be given to use of a lumber and sack capping or a flashboard capping. A lumber and sack capping is shown in plate 3, which may be used as a guide to estimate the materials required for a levee raise of about 3 feet. A flashboard structure is very similar, but the face of the structure is constructed of plywood instead of boards. These wooden facings provide a more positive control against excessive through seepage than is provided by sandbags alone. Either structure can be supported from behind with either sandbags or with compacted earthen fill, depending on how accessible the crown of the levee is to earthmoving machinery.

Additionally, plastic sheeting may be installed on the riverside face of the plywood or flashboards, to protect the wood and reduce seepage through the flashboards. Flashboards do tend to leak a little, depending on how they are constructed and how the boards expand when they're wet; though these structures are never constructed without a sandbag backing. If plastic sheeting is to be used, it should extend 1' riverward from the riverside bottom of the plywood/flashboard. A row of sandbags should then be stamped into place along the riverside bottom edge of the plywood/flashboards to help prevent seepage under the flashboard system. The plastic is brought up the riverside of the plywood/flashboards and over the top to the landside supports and held in place by sandbags or nails where necessary. Field conditions, the available time, and the availability of materials would dictate the actual requirements.

### **3. Seepage**

As a river or stream rises, the hydrostatic pressure against a levee slope increases significantly and can force water into and under the levee embankment. Even when a levee is properly constructed and of such mass to resist the destructive action of flood water, this seepage tends to push its way through regions of least resistance (such as sandy layers under the levee or animal burrows) out to the surface on the landward side of the structure. If there isn't sufficient pressure on the landward side to hold back the seepage water, it will break through the ground surface on the landward side, in the form of bubbling springs, which erode and carry soil particles from under the levee.

Seepage is almost impossible to eliminate and attempt to do so may create a much more severe condition. Seepage is generally not a problem unless 1) the landward levee slope becomes saturated over a large area, 2) seepage water is carrying material from the levee, or 3) pumping capacity is exceeded. Pumping of seepage should be held to a minimum, and ponding should be allowed during high water to the extent that it doesn't cause damages. Several levees were endangered during past floods by attempts to keep low areas pumped dry, and additional time and effort were expended in controlling sandboils caused by pumping. Therefore, seepage should be permitted if no apparent ill-effects are observed and if adequate pumping capacity is available.

#### **3.1 Effects of Underseepage**

Underseepage can produce three distinctly different effects on a levee, depending upon the condition of flow under the levee.

##### **a. Piping Flow**

In extreme conditions of excessive underseepage, the movement of seepage water erodes the foundation materials, and a clearly defined pipe or tube develops under the levee. Unless corrective actions are taken, water continues to erode and enlarge this pipe, so that a cavern develops under the levee, and levee material collapses to fill in the void. In an advanced state, piping under the levee can be identified by a slumping of the levee crown, and the levee can quickly fail if it's overtopped through this low spot. To prevent this condition from developing, any boils found to be transporting soil material need to be treated as early as possible.

##### **b. Non-Piping Flow**

In this case, seepage water flows under the levee without following a well-defined path, and results in one or more boils outcropping at or near the landside toe. The flow from these boils tends to undercut and ravel the landside toe, resulting in sloughing of the landward slope. Sloughing is the movement of small amounts of soils from the embankment slopes. Sloughing may also occur if the levee embankment becomes saturated as a result of prolonged high creek stages. Evidence of this type of failure is found in undercutting and raveling at the landside toe.

### **c. Saturating Flow**

In this case, numerous small boils, many of which are scarcely noticeable, outcrop at or near the landside toe. While no boil may appear dangerous in itself, a group of boils may cause significant damage. The flowing water may erode away supporting material and/or keep the area saturated and cause flotation ("quickness") of the soil, reducing the shearing strength of the material at the toe (where maximum shearing stress occurs) which could lead to slope failure. In a slope failure condition, a substantial section of the levee embankment breaks away along a clearly defined crack and slides away from the levee. The displacement of the soil will result in a reduction in the cross sectional area of the levee and poses a major threat to the integrity of the structure.

## **3.2 Sandboils**

### **a. Identification of Sand Boils**

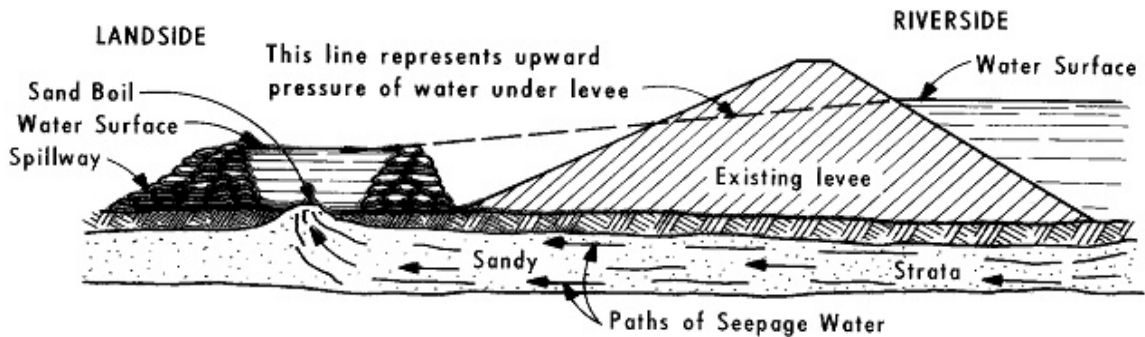
Sandboils usually occur within 10 to 300 feet from the landside toe of the levee and, in some instances, have occurred up to 1,000 feet away. Boils will have an obvious exit (such as a rodent hole), but the hole may be very small. When material is carried upward through a boil, it is deposited in a circular pattern around the exit location, and is comparable to an ant hill or volcano. Alternately, sandboils may exit into standing water. In this case, they may be difficult to identify, especially if the hole is small and the water cloudy from siltation. If you see any movement in what appears to be standing water on the landward side of the structure, this may be the exit point for a sandboil. Carefully approach the site, disturbing the water as little as possible, and let the water settle in order to look for the exit point. If there is no distinct hole, the water flow is not a threat. All boils should be conspicuously marked with flagging so that patrols can locate them without difficulty and observe changes in their condition.

You can tell how serious a boil is by the color of the water that is coming out. If the water is relatively clear, it means that there is relatively little material being eroded away through the boil. The site should be monitored regularly for changes, but nothing else should be done to treat the clear boil. If it's dark or muddy, then it's full of material that's been eroded away from under the levee, and must be treated immediately. Boils may quickly grow very large, and boils, which are discharging clear water, may suddenly begin to discharge soil materials along with the seepage flows. For this reason, any boil, whether the flow is clear or muddy, can potentially lead to the failure of the levee and must be monitored closely.

### **b. Treatment of Sandboils**

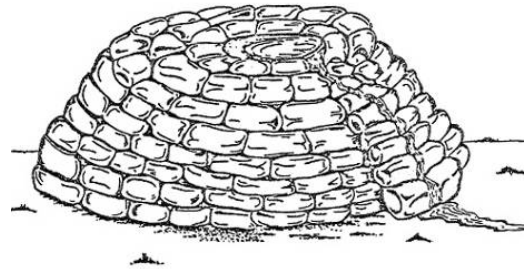
The most common and accepted method of treating sandboils that are displacing soil is to construct a ring of sandbags around the boil(s) as illustrated in Figure D.7. The purpose of the ring is to raise a head of water over the boil to counterbalance the upward pressure of the seepage flow. The height of the water column is adjusted so that the water exiting the boil runs clear and no longer removes soil from the levee foundation. It's extremely important that the flow of water is never stopped

completely, as this may cause additional boils to break out nearby. Treated areas should be kept under constant surveillance until the water recedes.

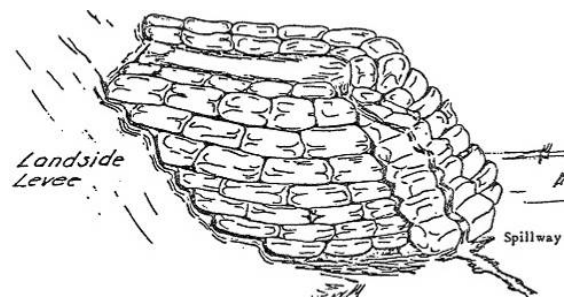


**Figure D.6** To treat the sandboil, the pressure of the seepage water is counterbalanced by hydrostatic pressure from the column of water in the ring levee.

The diameter and height of the ring will depend on the actual conditions at each sandboil. The base width should be at least 1½ times the contemplated height, and the inner ring of sandbags should begin between one and three feet from outer edge of the sandboil. "Weak" or "quick" ground near a boil should be included within the sack ring to prevent these areas from developing into new boils when the active boil is treated. Where several sandboils develop in a localized area, a ring levee of sandbags should be constructed around the entire area. The ring should ideally be of sufficient diameter to permit sacking operations to keep ahead of the flow of water. When a sandboil is located near the levee toe, the sandbag ring may be tied into the landside slope of the levee, as shown in Figure D.8.



**Figure D.7** Sketch of a typical ring levee with spillway.



**Figure D.8** Sketch of ring levee tied to a levee slope, with spillway. Construction against the levee slope results in a U-shaped sandbag "chimney."

The base or foundation for the sack ring should be cleared of debris and scarified to provide a reasonably watertight bond between the ground surface and the sandbags. The ring is constructed with sacks filled approximately two-thirds (2/3) full of sand, and tamped firmly into place. Do not tie the ends of the sacks. When adding subsequent layers, the joints should be staggered for stability and water tightness. The untied ends of sandbags should be laid towards the inside of the ring and folded under. The height of the sack ring should be only sufficient to slow the flow until the water

exiting the boil runs clean. Never place sandbags directly over the sandboil or attempt to completely stop the flow through the boils, as this may result in other boils developing nearby.

A spillway or exit channel should be constructed on the top of the sack ring so that the level of the water in the ring levee can be adjusted, and the overflow water can be carried a safe distance from the boil, away from the direction of the levee. Because the height of the water is the critical factor in adjusting the rate of flow through the boil, the spillway will require constant monitoring and adjustment once the sandbag ring levee is filled with water. This spillway is normally constructed of sandbags, but alternately, a V-shaped drain can be constructed of two boards; or PVC pipe, plastic sheeting, or other materials may be helpful in building the spillway.

**c. Material, Tools, and Labor Requirements for Sandbag Ring Levee:**

Materials, tools, and labor required to construct a Sandbag Ring Levee 2½ feet high and 10 feet in diameter with a haul distance of 1 mile round trip.

**i. Materials and Tools:**

- 1,125 Sandbags
- 5 Shovels, long or short handle
- 9 Tons of sand (approximately)
- 5 Pick up trucks
- 2 Radios or cell phones (one at filling site; one at laying site)
- 2 Emergency light sets
- 15 Flashlights
- 15 Pairs of work gloves

**ii. Labor Requirements:**

- 4 Filling sandbags
- 3 Loading/ carrying
- 5 Hauling to work site
- 3 Laying (placement)
- 2 Foremen (1 at sandbag filling site 1 at work site)
- 17 People required, total**

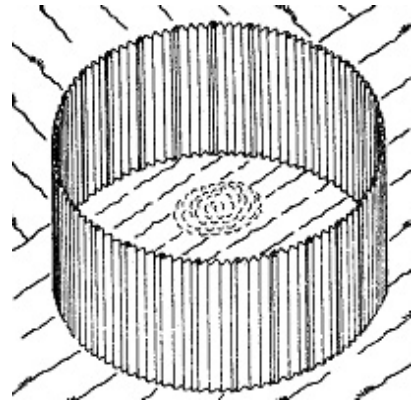
**iii. Time Requirements:**

With given resources, time for construction is estimated to be 1-½ hours from start to finish.



#### **d. Alternate Methods of Treating Sandboils**

An alternate method of ringing sandboils is by use of corrugated sheet-steel piling, as shown in Figure D.9. The area is cleared of debris, and the piling is driven about 1-½ feet into the ground around the boil. This method accomplishes the same task faster than sandbagging, but is limited in use by the availability of material, equipment, and the location and foundation condition of boils. Expedient methods can be improvised in other ways, to include using sections of corrugated metal piping. Special care must be taken with the design of these structures to make sure there is a reliable means for adjusting the water level, so the water column doesn't completely stop the flow of water through the boil.



**Figure D.9** A ring of steel-sheet piling can alternately be used to ring the boil, if conditions permit.

Alternately, it may sometimes be possible to locate the inlet side of a boil under the water on the riverward bank of the levee. A swirl may be observed in the water at this point, or the location of the entry point may have been identified after a previous high water event. Sometimes, because of the current, the swirling vortex appears on the water's surface slightly downstream of the actual opening. If the opening is located, it may be possible to block the seepage flow at its entry point, since blocking the entry point may take much less time than constructing a sandbag ring levee. If the entry point is located, it can be blocked by anchoring a sheet of plastic over the area, using rope and sandbags. It may sometimes be possible to plug a flooded animal burrow by placing a mixture of manure and straw or dry hay into the water at the burrow entrance. If the entry point is blocked, both the blockage and the location of boil need to be closely monitored for any changes.

### **3.3 Sloughs**

If seepage causes saturation and sloughing of the landward slope, the slope should ideally be flattened to 1V (vertical) on 4H (horizontal) or flatter. Material for flattening should be at least as pervious as the embankment material. If any sloughs develop in the levee, all soft areas should be thoroughly drained by excavating shallow ditches in the side slopes, as shown in Plate 4. Contact your Corps district office before undertaking this method.

### **3.4 Floating Soil Conditions**

When seepage exits landward of the levee toe at a pressure that creates a sensation like the soil is fluid, the levee and foundation become susceptible to sliding and/or sloughing which can lead to an embankment failure. A fluid soil condition is an indicator that soil particles or the soil mass is floating, and the soil's ability to support a load such as a vehicle or heavy equipment and/or the levee embankment itself has been reduced. When this condition is observed, the safety, health and welfare of those individuals who are responding to the flood fight and/or those who live within the protected area must come first. Consideration must be given to evacuating the area. If the sod layer appears to pop loose or lift up, evacuate the area immediately. In a past flood, this condition was observed and successfully solved with the placement of clean, free-draining sand fill, classified as SP medium to fine sand, with less than 5 percent fines passing the number 200 sieve. The sand was brought in from another location (away from the levee), and a bulldozer was used to push the sand over the area, creating a blanket some 3 feet in thickness and some 20 feet in width. The thickness and width necessary may vary depending on the observed conditions.

### **3.5 Other Seepage Related Considerations**

Any basement or similar depression near the levee should be closely watched for heaving of floors, caving of walls, and boil activity. It may become necessary to support basement walls or weight down basement floors by intentionally flooding the basement with clean water, to prevent walls from caving in, piping, or excessive seepage.

## **4. Erosion**

### **4.1 Wave Wash**

During high water, continuing wave action against a levee slope can erode wide terraces along the length of the levee. This causes scour or beaching along the riverward slope of the levee and reduces the cross sectional area, which can potentially lead to a failure. This type of damage doesn't typically arise during short (hour-long) storms, especially if the slope has good sod cover. However, during longer periods of high water, especially during windy or icy conditions, the damage can develop very rapidly. The section leader should study the levee beforehand to assess the potential for wave wash. All potential trouble areas should be located well in advance, and section leaders should assemble a reserve supply of materials (filled sandbags, lumber, stakes, plastic sheeting, rock, etc) close to locations most likely to experience such damage. During periods of high wind and high water, when waves attack a levee, ample labor should be assembled and experienced personnel should patrol the areas to identify the beginnings of scour, washouts, or breaching. Because wave wash damage can spread rapidly, it is important that damaged areas are treated as soon as they are identified. There are a number of accepted methods of protecting a levee against wave wash.

#### **a. Sandbags**

In emergency situations, the preferred treatment method is to place sandbags in to the cut as shown in Plate 5. The filled sacks should be laid in sections of sufficient length to give protection well above the anticipated rise.

#### **b. Plastic Sheeting and Sandbags**

Experience has shown that a combination of plastic sheeting and sandbags is one of the most expedient, effective and economical methods of combating slope attack in a flood situation. Other materials such as snow fence, cotton, or burlap have successfully been used in place of the plastic in the past. Poly and sandbags can be used in a variety of combinations, and time becomes the factor that may determine which combination to use. Ideally, poly and sandbag protection should be placed in the dry. However, many cases of unexpected slope attack will occur during high water, and a method for placement in the wet is covered below. See Plates 6 and 7 for recommended methods of laying poly and sandbags. Plate 8 shows a minimal configuration for emergency use. Since each flood fight project is generally unique (river, personnel available, materials, etc.), specific details of placement and materials handling will not be covered, though some guidelines are provided below. Field personnel must be aware of resources available when using poly and sandbags.

##### **i. Dry Placement**

Anchoring the poly along the riverward toe is important for a successful job. It may be done in three different ways: 1) after completion of the levee, a trench excavated along the toe, poly placed in the trench, and the trench backfilled; 2) poly placed flat-out away from the toe, and earth pushed over the flap; 3) poly placed flat-out from the toe and one or more rows of sandbags placed over the flap. The poly should then be unrolled up the slope and over the top enough to allow for

anchoring with sandbags. Poly should be placed from downstream to upstream along the slopes and overlapped at least two feet. The poly is now ready for the "hold-down" sandbags.

It is mandatory that poly placed on levee slopes be held down along the slopes as well. An effective method of anchoring poly is a grid system of sandbags, unless extremely high velocities, heavy debris or a large amount of ice is anticipated. Then, a solid blanket of bags over the poly should be used. A grid system can be constructed faster and requires fewer bags and much less labor than a total covering. Various grid systems include vertical rows of lapped bags, two-by-four lumber held down by attached bags, and rows of bags held by a continuous rope tied to each bag. Poly has been held down by a system using two bags tied with rope and the rope saddled over the levee crown with a bag on each slope.

### **ii. Placement in the Wet**

In many situations during high water, poly and sandbags placed in the wet must provide the emergency protection. Wet placement may also be required to replace or maintain damaged poly or poly displaced by current action. Plate 7 shows a typical section of levee covered in the wet. Sandbag anchors are formed at the bottom edge and ends of the poly by bunching the poly around a fistful of sand or rock, and tying the sandbags to this fist-sized ball. Counterweights consisting of two or more sandbags connected by a length of 1/4-inch rope are used to hold the center portion of the poly down. The number of counterweights will depend on the uniformity of the levee slope and current velocity. Placement of the poly consists of first casting out the poly sheet with the bottom weights and then adding counterweights to slowly sink the poly sheet into place. The poly, in most cases, will continue to move down slope until the bottom edge reaches the toe of the slope. Sufficient counterweights should be added to insure that no air voids exist between the poly and the levee face and to keep the poly from flapping or being carried away in the current. For this reason, it is important to have enough counterweights prepared prior to the placement of the sheet.

### **iii. Overuse of Plastic Sheeting**

In past floods, there has been a tendency to overuse and in some cases misuse poly on slopes. For example, on well-compacted clay embankments, in areas of relatively low velocities, use of poly would be excessive. Plastic should never be used on the landward slopes, as it holds through-seepage against the levee slope. A critical analysis of a situation should be made before poly and sandbags are used, with a view toward less waste and more efficient use of these materials and available manpower. However, if a situation is doubtful, poly should be used rather than risk a failure. Critical areas should have priority.

**c. Moveable Panels**

Wave wash may also be effectively checked by the use of movable panels constructed of lumber. These panels are anchored in place on the levee slope with stakes and are weighted down with sandbags or stone as shown on Plate 9. A portable bulkhead constructed with lumber and staked into place is another alternate type of wave wash protection.

**d. Miscellaneous Measures**

Several other methods of slope protection have been used. Straw bales pegged into the slope were successful against wave action, as was straw spread on the slope and overlain with snow fence.

**4.2 Scours**

Scouring occurs when the current velocity against the levee is adequate to remove levee embankment materials. Once scouring begins to occur, the protective sod cover is damaged or destroyed and additional scour may develop very quickly. Careful observation should be made along the entire length of the riverside of the levee during high water periods, and especially in locations where the current flow is two feet per second or more. Scouring will most likely develop at road crossing ramps and at locations where pipes, sewers, and other structures penetrate the levee. It may also develop in ditches, excavations or building basements near the levee, around riverside stability berms, or in other locations where there is an obstruction to the smooth flow of water along the levee face. If any scour is observed, soundings should be taken if possible to determine the extent of damage and the amount of treatment required.

**a. Deflection Weirs**

Deflection weirs (also known as bendway weirs), extending 10 feet or more into the channel have been effective in deflecting current away from the levees. These emergency structures can be constructed using lumber, stakes, brush, sandbags, and stone, and are tied in place as shown on Plates 10 and 11. Snow fence, plain riprap, compacted earth or any other substantial materials available may also be used; even old car bodies have been used in the past. Preferably, the weirs should be placed in the dry at locations where severe scour may be anticipated, because construction during high water will be very difficult. A series of weirs may be needed to protect the area, or a longer weir may be constructed in the water parallel to the levee. Care should be given in the placement of weirs, because haphazard placement may shift the current towards other banks and lead to even worse scouring. Hydraulic technical assistance should be sought if questions arise in the use of emergency weirs.

**b. Plastic Sheeting**

Plastic sheeting may be useful in protecting the embankment from scouring, as described under the previous section on wave wash.

### c. Other Protection

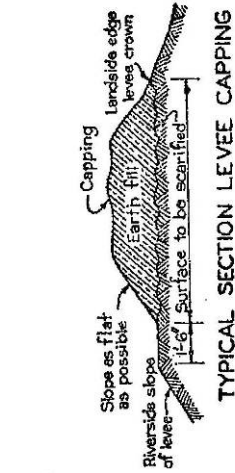
If scour begins to take place after water is up on the levee, a protective berm should be constructed over the entire scour area using stone, slag, or other durable material with sufficient size and weight withstand the erosive velocity of the current. Construction of this berm will generally require equipment capable of operating from the levee crown. Riprap has been used to provide slope protection where erosive forces were too large to be effectively controlled by other means. Objections to using riprap when flood fighting include the cost and the large quantities that are typically necessary to protect a given area. It's usually very difficult to control the placement of the riprap, particularly during times of high water, but careful use of an excavator has been effective even in difficult conditions.



**Figure D.10** *Placement of Riprap. Careful use of an excavator may allow for more accurate placement than is shown above.*

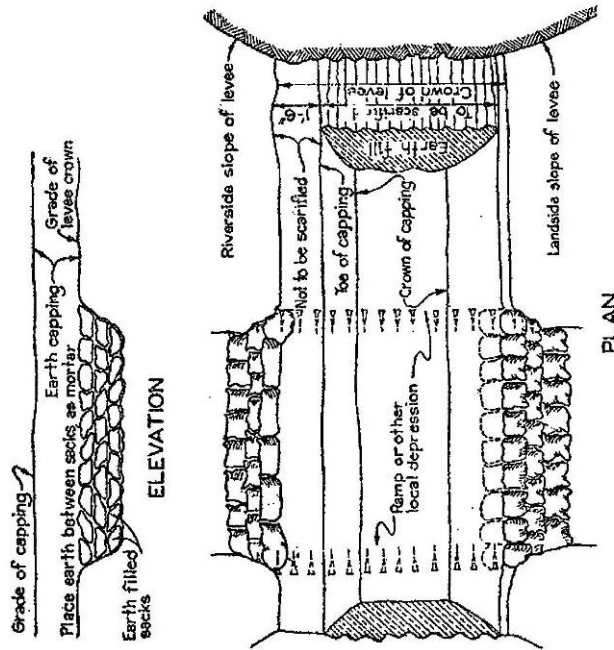
### 4.3 Ice and Floating Debris

Sometimes ice conditions are such that protection provided by the methods outlined above will not be totally effective. The primary method for protecting a levee slope from debris or ice attack is to construct a floating boom parallel to the levee embankment. Logs, driftwood, or any available timber are cabled together end to end and moored to the ground in such a way that they float out in the current about 15 feet from the water's edge. Depending on the size of the logs, the boom will deflect floating objects. Since a detailed discussion of ice jams lies beyond the scope of this manual, please refer to the references in Appendix I for additional information.



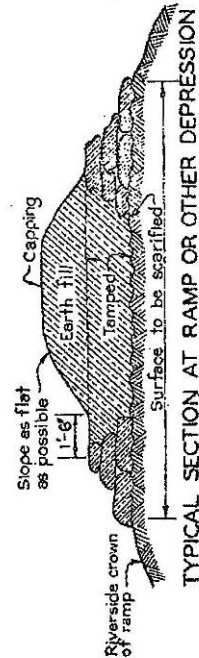
TYPICAL SECTION LEVEE CAPPING

NOTE: This type of capping not to be used on levees with crown less than 10' wide or on levees exposed to wave wash.



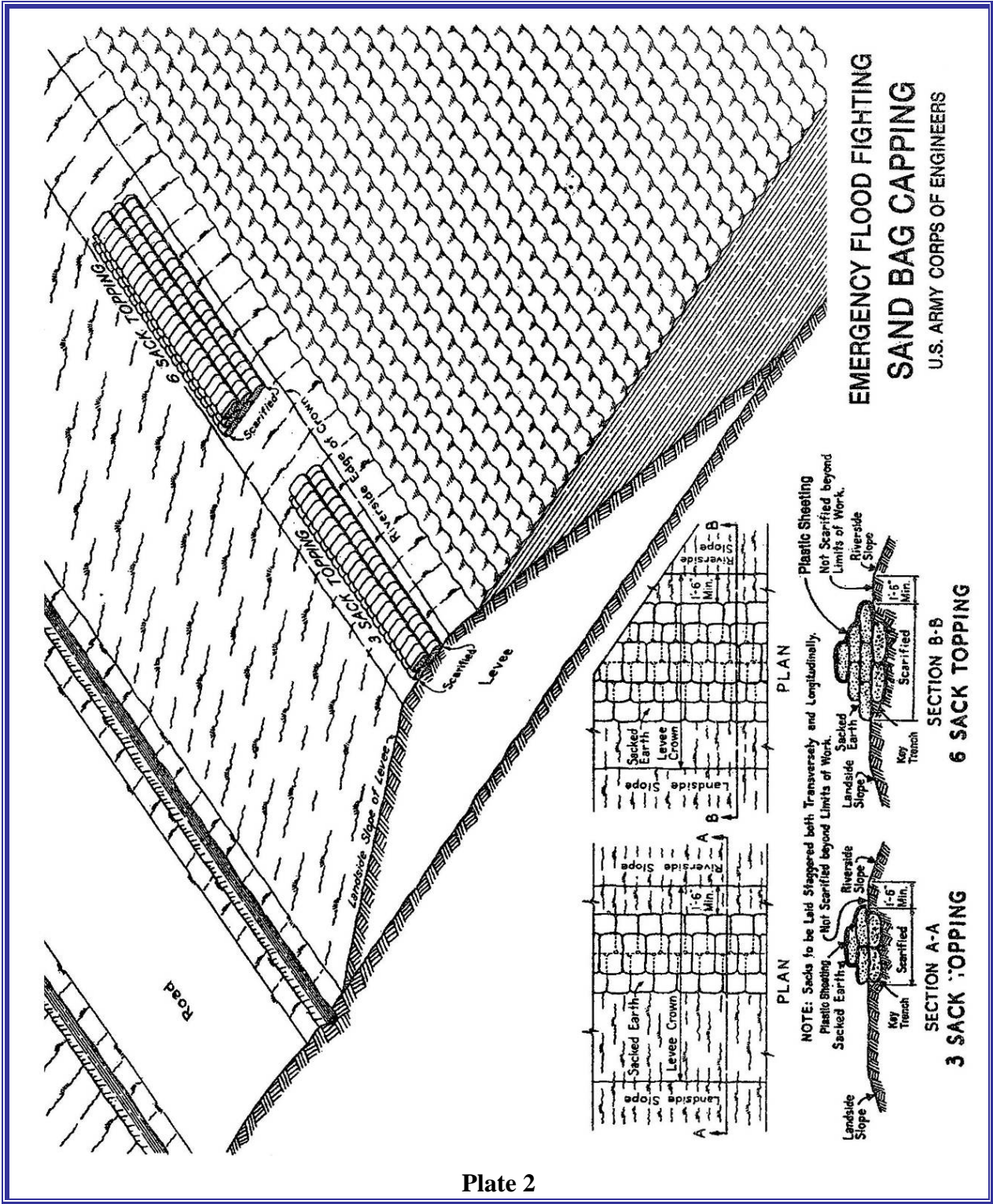
PLAN

EMERGENCY FLOOD FIGHTING  
**EARTH CAPPING**  
 FOR RAISING DEPRESSIONS AND LEVEE CAPPING  
 (THIS DESIGN IS ADEQUATE FOR HEIGHTS UP TO 1½')  
 U.S. ARMY CORPS OF ENGINEERS

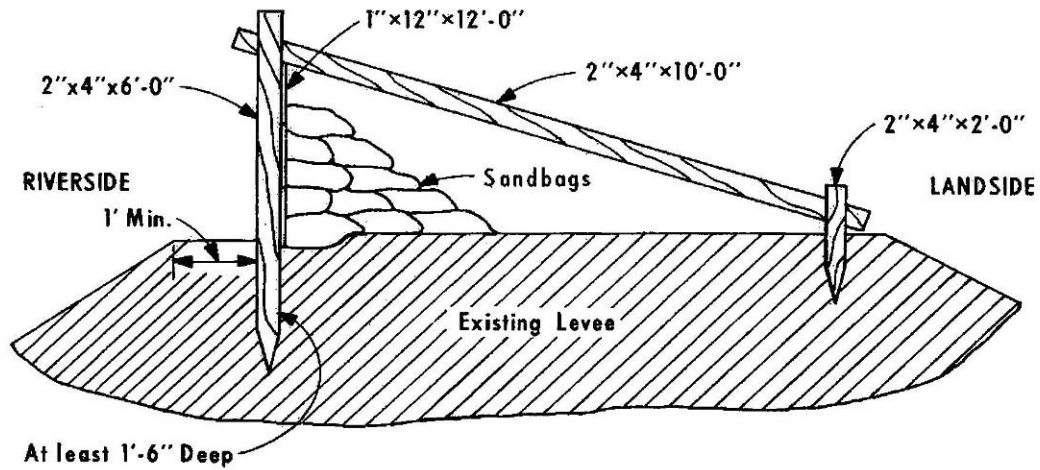


TYPICAL SECTION AT RAMP OR OTHER DEPRESSION

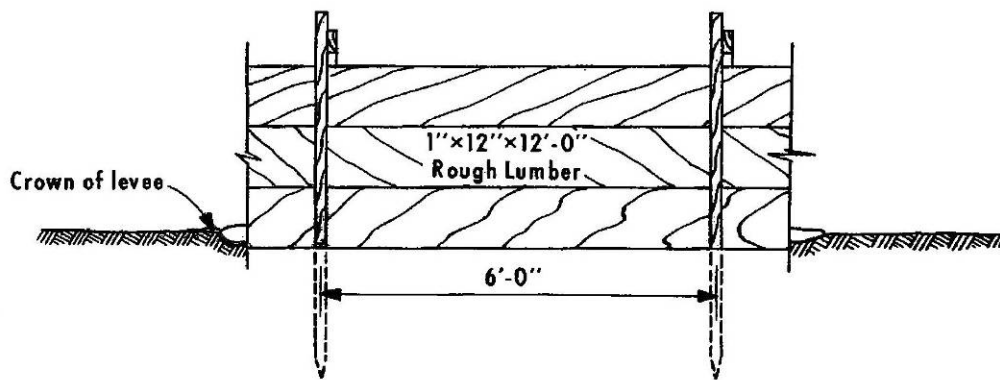
Plate 1







**SECTION**



**FRONT ELEVATION**

BILL OF MATERIAL FOR 100 FT.	
<b>LUMBER</b>	
25 pieces	1'x12'x12'-0"
17 pieces	2'x4'x10'-0"
17 pieces	2'x4'x6'-0"
17 pieces	2'x4'x2'-0"
<b>NAILS</b>	
2 lbs	8d Common
2 lbs	16d Common
<b>SANDBAGS</b>	
1100	Filled Bags

**CONSTRUCTION METHODS**  
 FOR  
**HIGH WATER**  
**LUMBER AND SACK TOPPING**  
 U. S. ARMY CORPS OF ENGINEERS

**Plate 3**

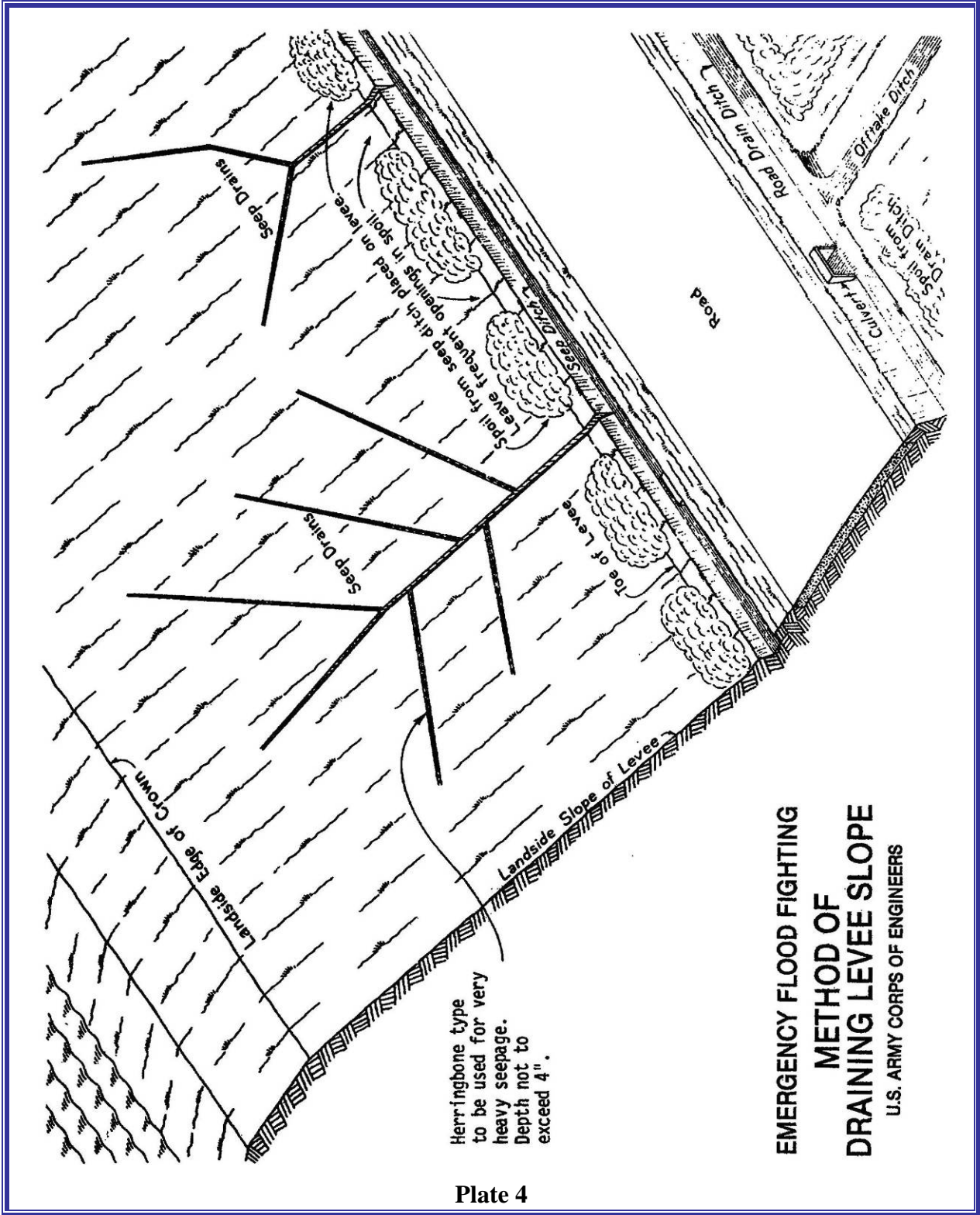


Plate 4

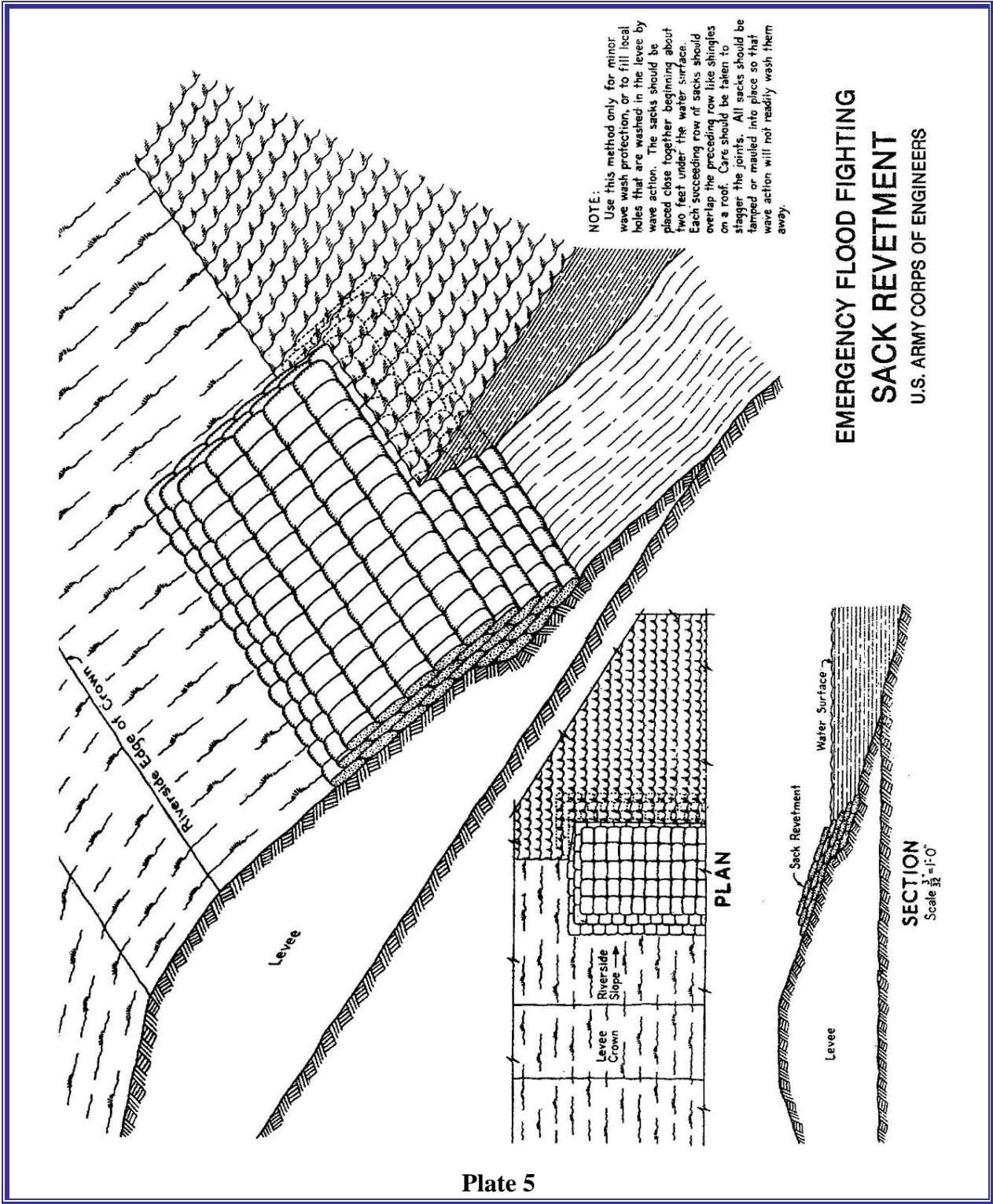
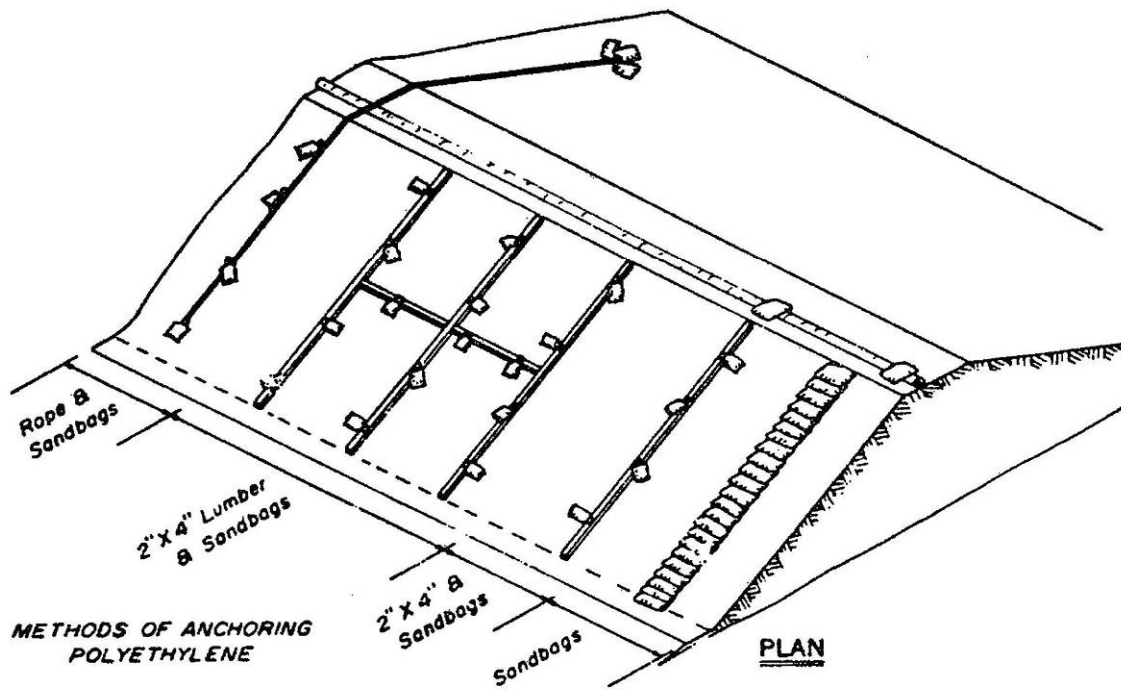
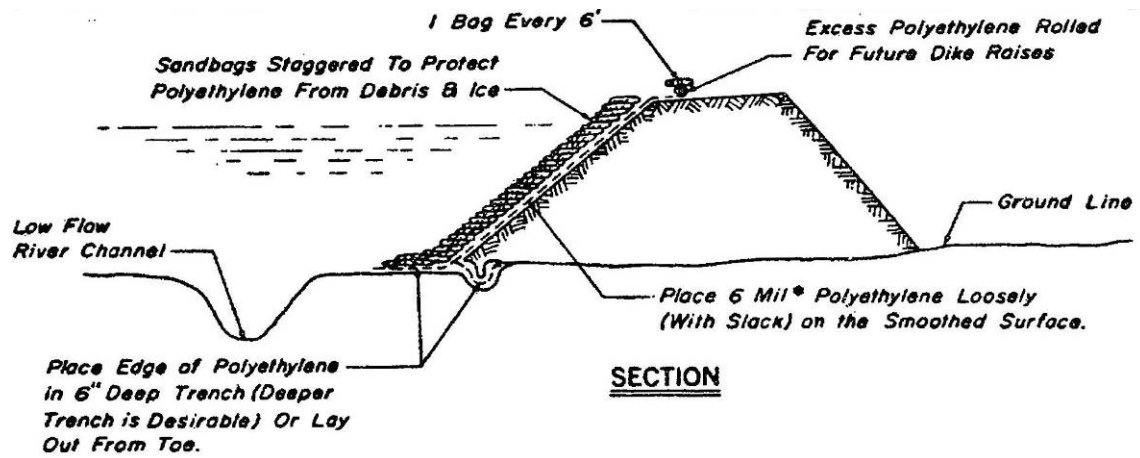


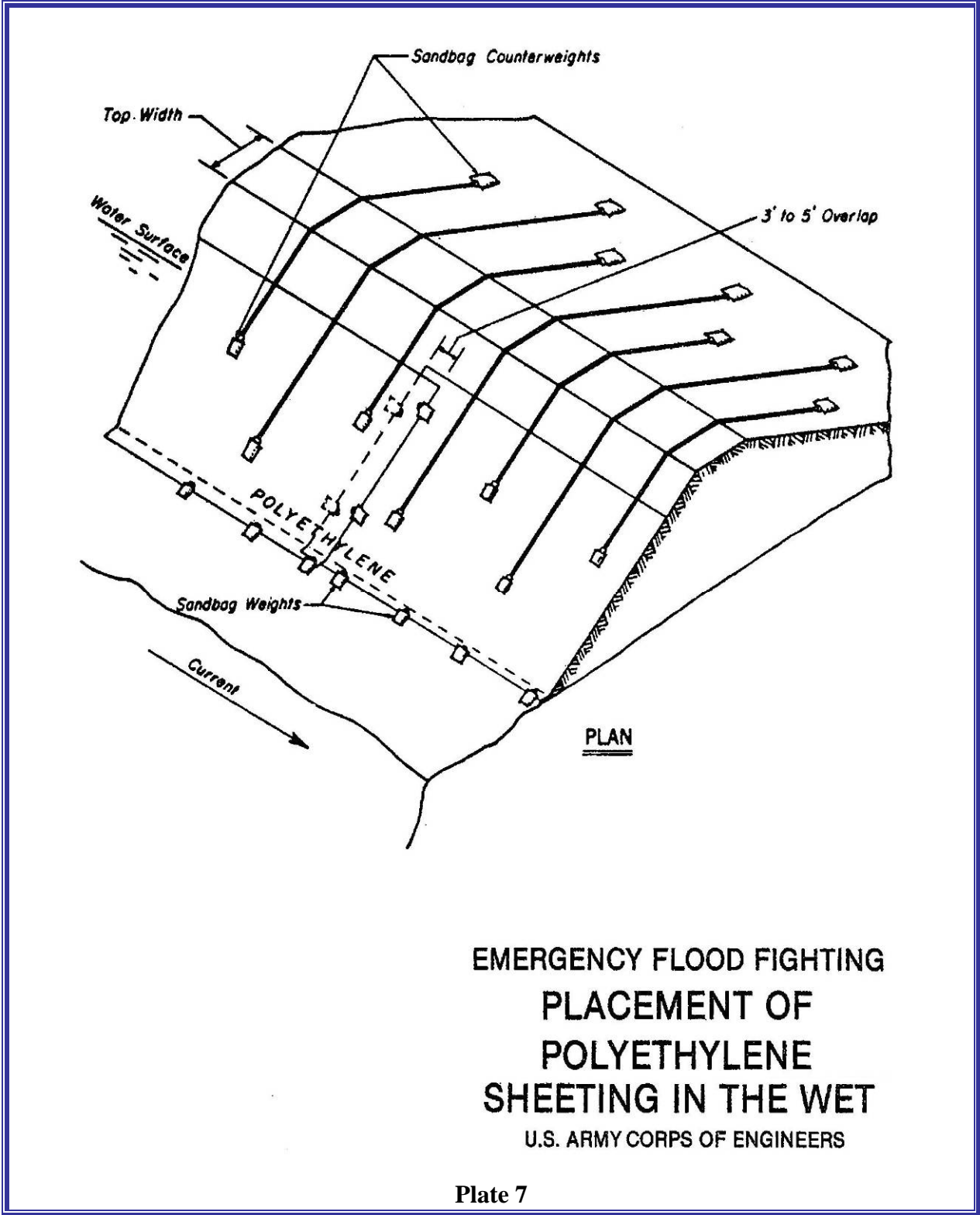
Plate 5

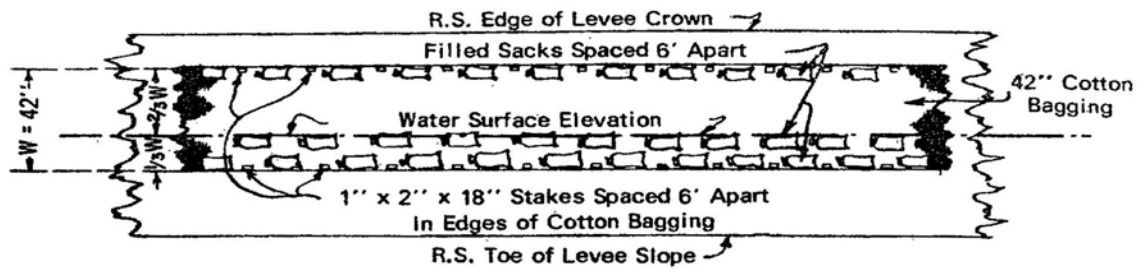


\* 6 Mil Black Polyethylene is the most Desirable, 6 Mil Clear Second, 4 Mil Black Third, 4 Mil Clear Fourth & 2 Mil Polyethylene Should Only Be Used As A Last Resort.

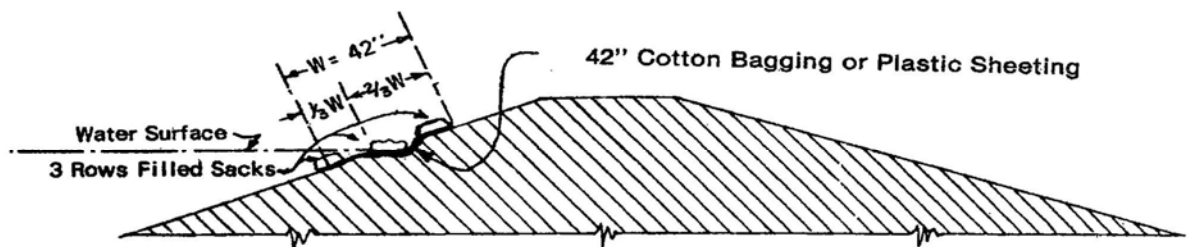
**EMERGENCY FLOOD FIGHTING  
POLYETHYLENE  
LEVEE PROTECTION**  
U.S. ARMY CORPS OF ENGINEERS

Plate 6





PLAN



CROSS SECTION

BILL OF MATERIAL  
TO CONSTRUCT 180 FT.

- 1 Roll Jute Cotton Bagging 42" x 180'
- 90 Filled Sacks
- 60 Stakes 1" x 2" x 18" = 15 Bd. Ft.

INSTRUCTIONS

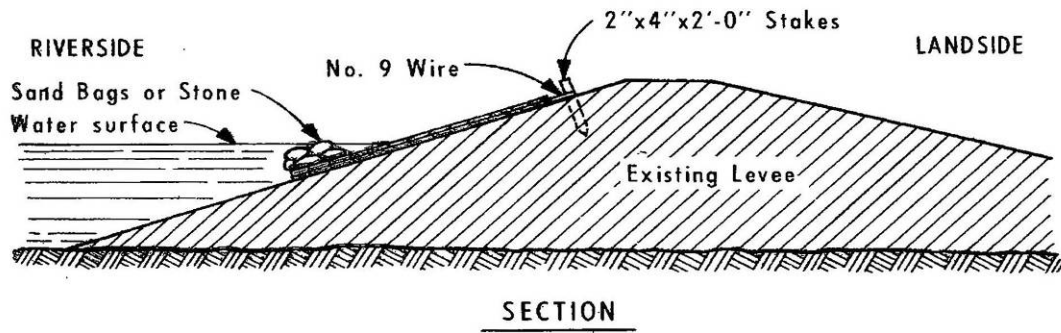
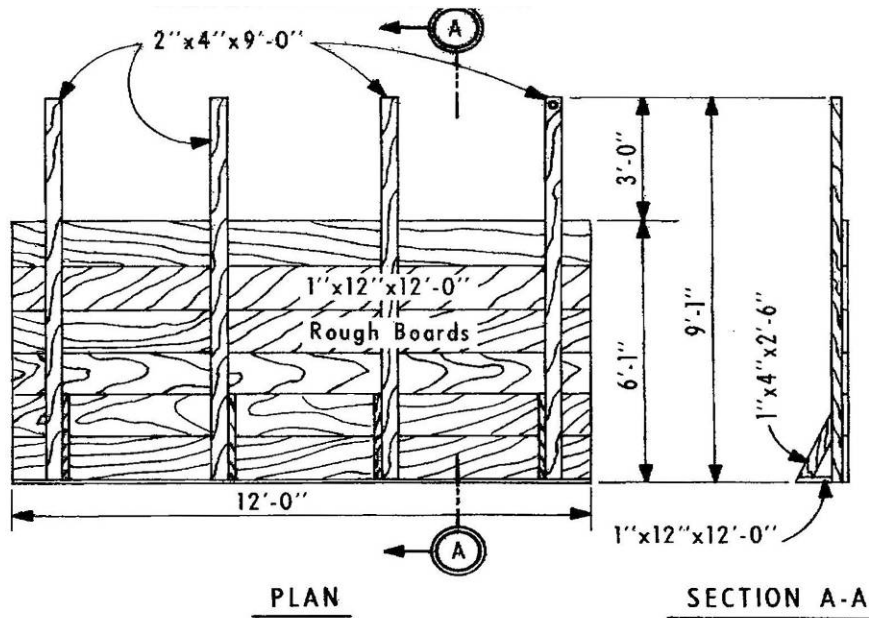
Lay 42" cotton bagging (Jute) longitudinally along riverside slope of levee with approximate 2/3 width above water surface.

Weight bagging along edges and at water surface with filled sacks spaced approximately 6' apart. Drive stakes alternately between sacks along both edges of bagging.

If additional width is required, lace two or more widths of bagging together and lay as desired.

**EMERGENCY FLOOD FIGHTING  
TYPE OF WAVEWASH PROTECTION**

U.S. ARMY CORPS OF ENGINEERS



BILL OF MATERIAL FOR 100 FT.	
<b>LUMBER</b>	
55 Pieces	1"x12"x12'-0"
32 Pieces	1"x4"x2'-6"
32 Pieces	2"x4"x9'-0"
32 Pieces	2"x4"x2'-0"
<b>WIRE</b>	
100 Ft.	No. 9
<b>NAILS</b>	
6lbs.	8d Common

**CONSTRUCTION METHODS**  
 FOR  
**HIGH WATER**  
**WAVE WASH PROTECTION**  
**MOVABLE**  
 U. S. ARMY CORPS OF ENGINEERS

**Plate 9**

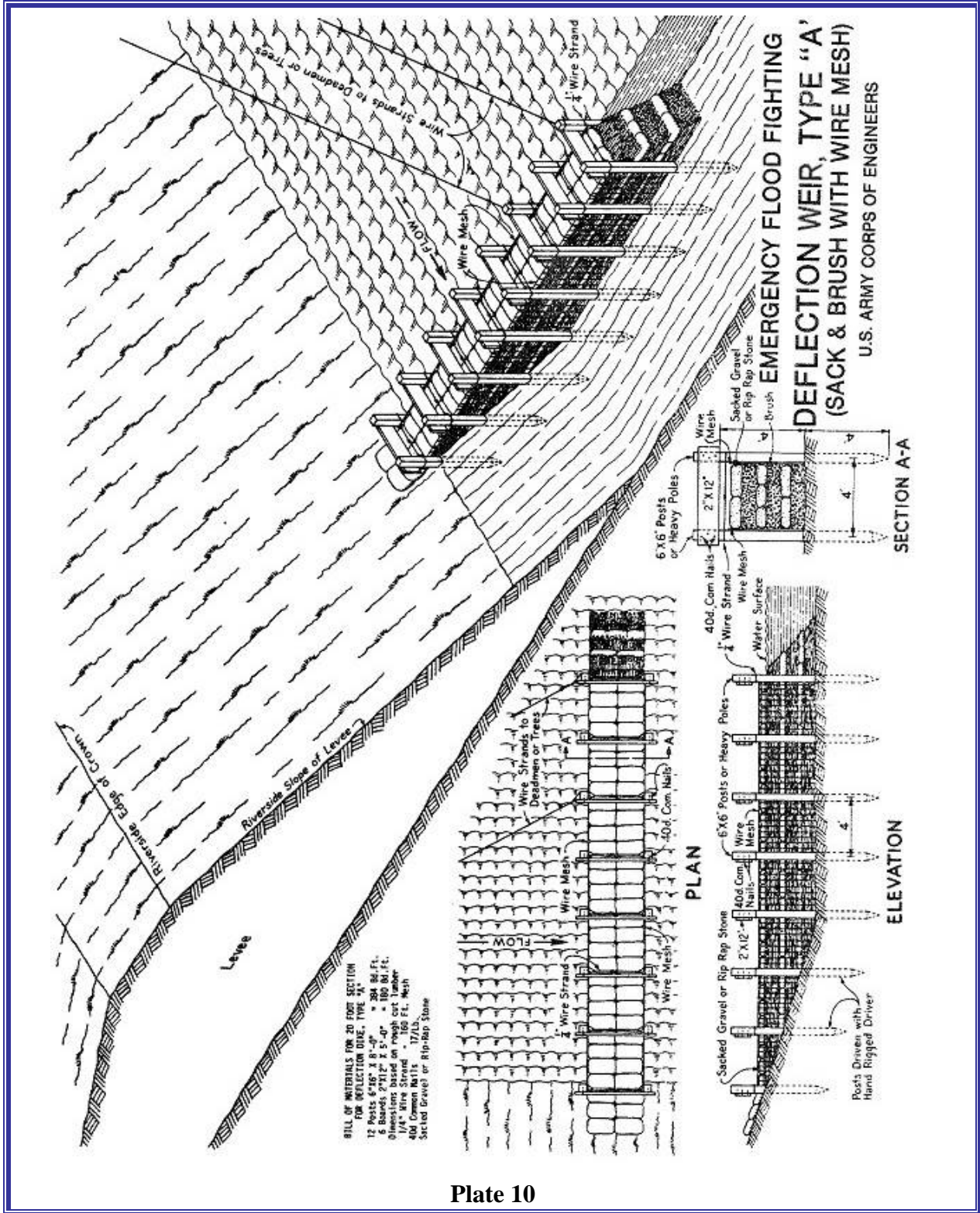


Plate 10



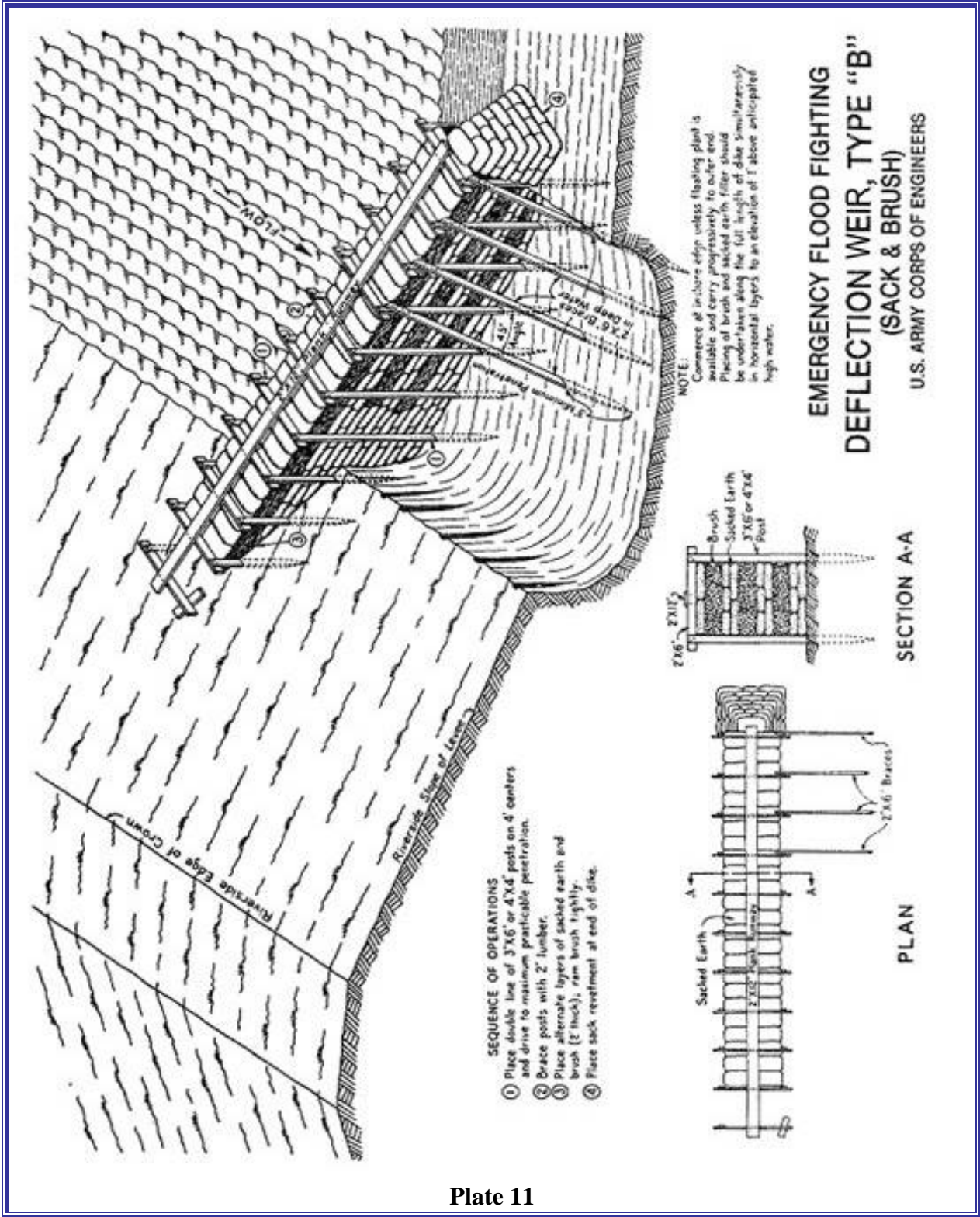
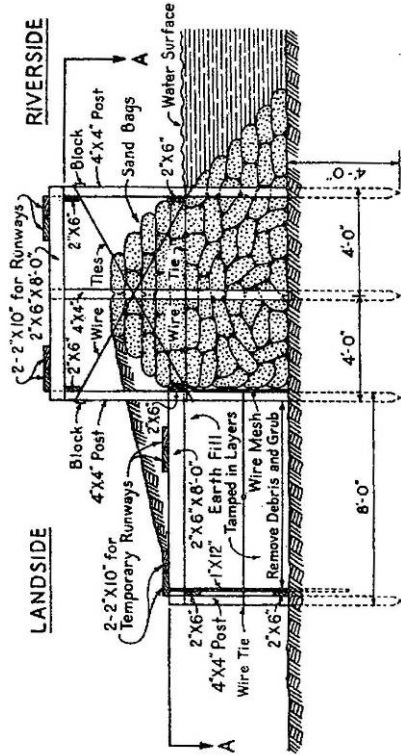
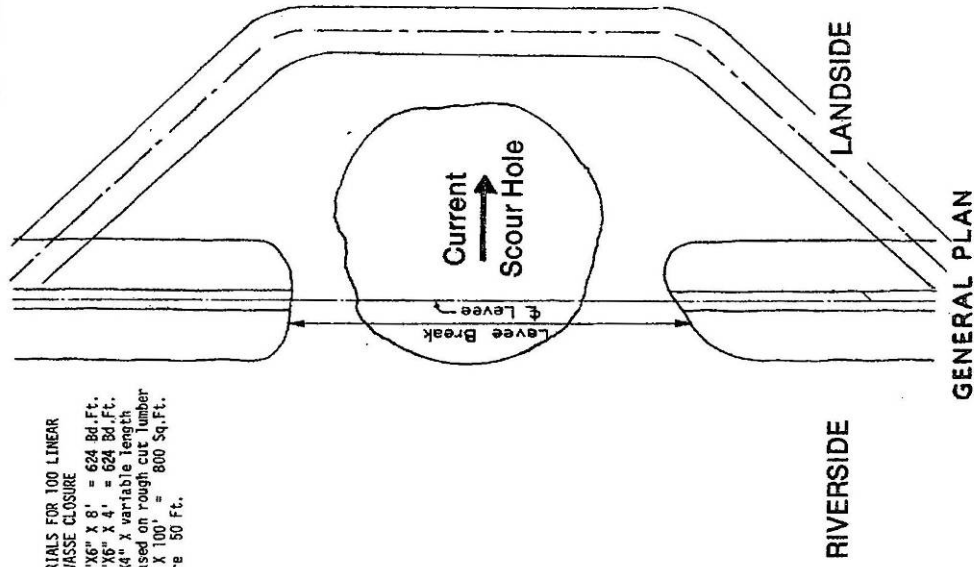


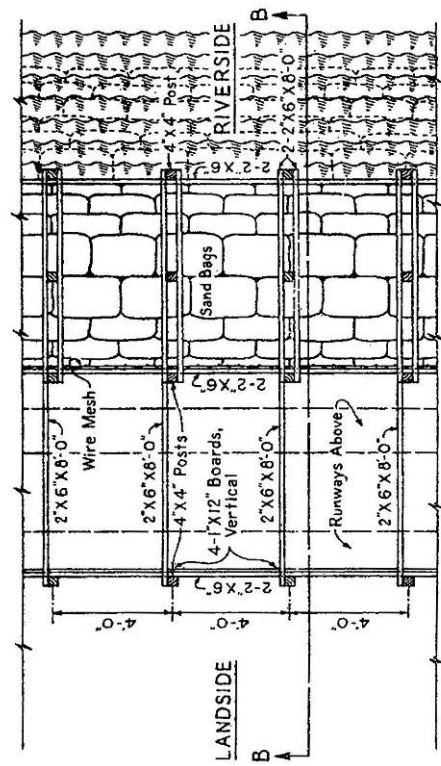
Plate 11

**BILL OF MATERIALS FOR 100 LINEAR FEET CREVASSE CLOSURE**

- 78 Boards 2"x6" X 8' = 624 Bd.Ft.
- 156 Boards 2"x6" X 4' = 624 Bd.Ft.
- 104 Posts 4"x4" x variable length
- Directions based on rough cut lumber
- Wire Mesh 8' X 100' = 800 Sq.Ft.
- 4 Roll's Wire 50 Ft.



**SECTION B-B**

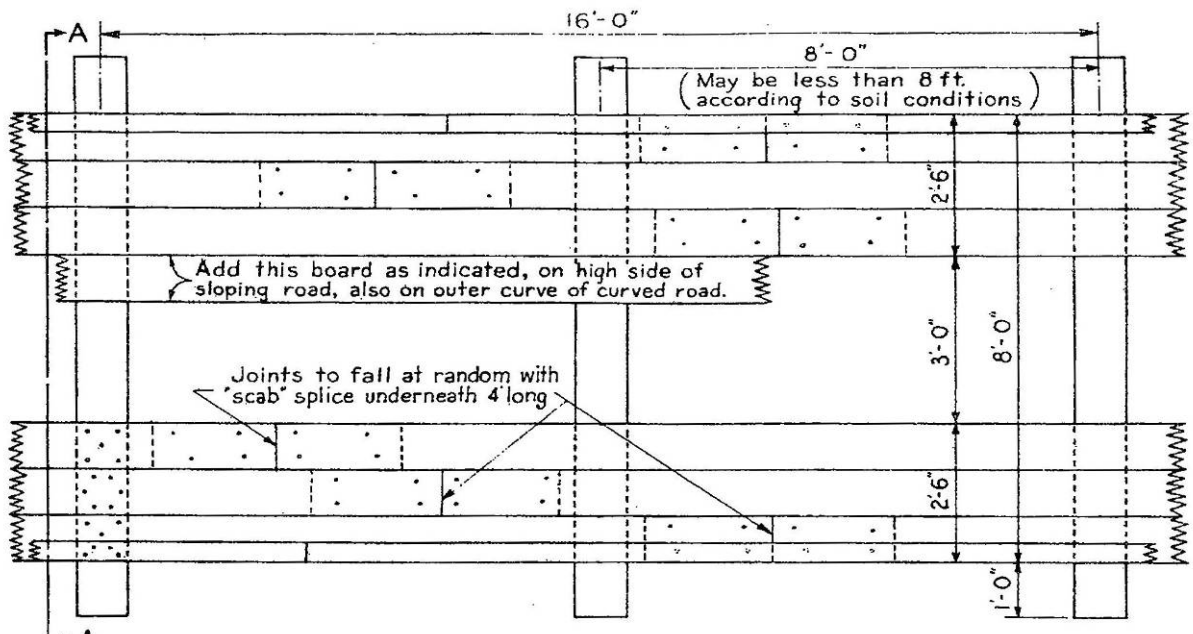


**PLAN AT A-A**

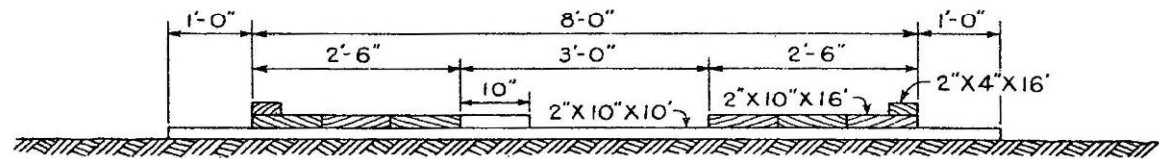
NOTE:  
2"x4" Braces may be used instead of wire ties.

**EMERGENCY FLOOD FIGHTING  
CREVASSE CLOSURE**  
U.S. ARMY CORPS OF ENGINEERS

**Plate 12**



**PLAN**  
Scale  $\frac{3}{8}'' = 1'-0''$



**SECTION A-A**  
Scale  $\frac{1}{2}'' = 1'-0''$

**BILL OF MATERIALS FOR  
100 LINEAR FEET OF ROADWAY**

Cross Members	13 Pcs.	2" X 10" X 10'	=	217 Bd. Ft.
Road Bed	38 Pcs.	2" X 10" X 16'	=	1014 Bd. Ft.
Guard Rail	13 Pcs.	2" X 4" X 16'	=	139 Bd. Ft.
				<u>Total 1370 Bd. Ft.</u>

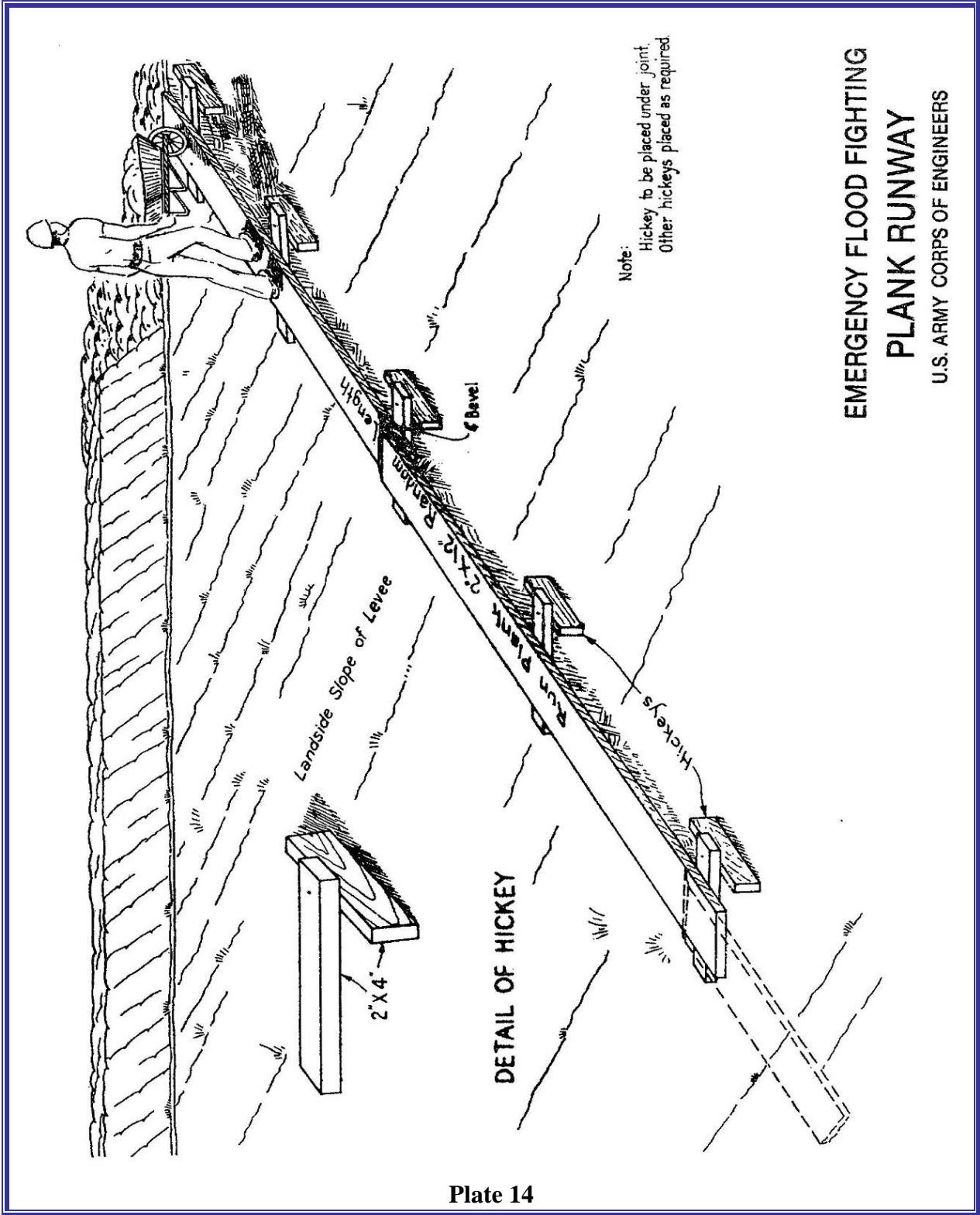
18 Lbs. 30d. Common Nails  
10 Lbs. 60d. Common Nails  
Kind of Lumber: Hardwood, Rough.  
Actual quantities. No allowance made for waste.

**NOTE:**  
Where foundation is very soft, 12 ft. flooring should be used with cross members at 6 ft. centers. In this case add approximately  $33\frac{1}{3}\%$  or  $\frac{1}{3}$  to Bill of Materials at left, for 100 ft. of roadway.

\* Random not less than 12'

**EMERGENCY FLOOD FIGHTING  
PLANK ROAD**  
U.S. ARMY CORPS OF ENGINEERS

**Plate 13**



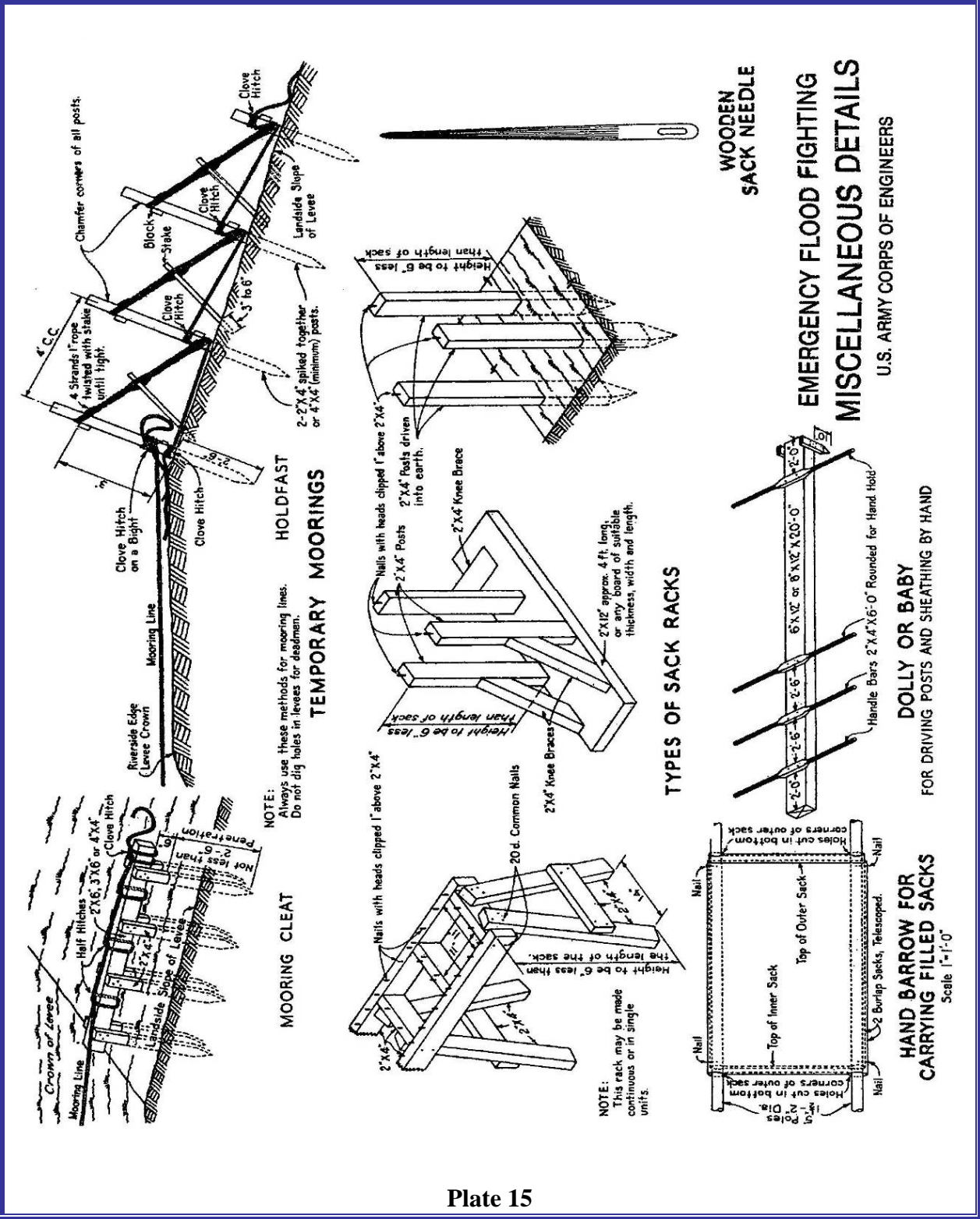


Plate 15

This page intentionally left blank.

## APPENDIX E: REHABILITATION REQUEST FORM

U.S. Army Corps of Engineers, _____ District	Date of
Request: _____	
ATTN: Emergency Management Branch	
Street Address	
City, State ZIP+4	
Dear Sir:	
The purpose of this letter is to request Rehabilitation Assistance from the Corps of Engineers under Public Law 84-99 for the repair of the _____ levee (or other type of flood control project) that was damaged by (flood)(high waters) during _____ 20____. The project is Active in the Rehabilitation and Inspection Program, and was last inspected by the Corps of Engineers on _____. The location of the levee and a brief description of the damage are as follows:	
Project Identification Number _____	River or Stream _____
Bank (circle): Left, Right, Both	
Description of Damage _____	
_____	
City _____	County _____ State _____
Section _____	Township _____ Range _____
Public Sponsor Point of Contact:	
Name _____	
Address _____	City _____ State _____
Telephone (W) _____	(H) _____
If this project is eligible for PL 84-99 Rehabilitation Assistance, I further request that the Corps of Engineers take all necessary steps to accomplish the appropriate repairs. It is agreed that the required items of local cooperation will be provided should the levee be eligible for Rehabilitation Assistance under PL 84-99 and the repair work is accomplished by the Corps of Engineers.	
I hereby certify that the right-of-way which is required for any authorized repair work is presently available, and this letter constitutes permission for the Government and its agents to enter and use said right-of-way in undertaking authorized repair work.	
Sincerely,	
_____	

This page intentionally left blank.



# APPENDIX F: Cooperation Agreement for Rehabilitation of Non-Federal Flood Control Works

**COOPERATION AGREEMENT  
BETWEEN  
THE UNITED STATES OF AMERICA  
and**

-----  
**for  
REHABILITATION OF A NON-FEDERAL FLOOD CONTROL WORK**

**THIS AGREEMENT**, entered into this \_\_\_\_ day of \_\_\_\_\_, 20\_\_\_\_, by and between THE DEPARTMENT OF THE ARMY (hereinafter referred to as the "Government") represented by the District Engineer, \_\_\_\_\_ District, U.S. Army Corps of Engineers, and the \_\_\_\_\_ [PUBLIC SPONSOR], (hereinafter referred to as the "Public Sponsor"), represented by \_\_\_\_\_ [TITLE OF PERSON SIGNING THIS AGREEMENT].

**WITNESSETH THAT:**

**WHEREAS**, pursuant to 33 U.S.C. 701n, the Government is authorized to assist in the repair or restoration of flood control improvements threatened or destroyed by flood;

**WHEREAS**, via written correspondence, the Public Sponsor has requested the Government to repair or restore a certain flood control work damaged by recent flooding or coastal storms, in accordance with 33 U.S.C. 701n and established policies of the U.S. Army Corps of Engineers; and,

**WHEREAS**, the Public Sponsor hereby represents that it has the authority and legal capability to furnish the non-Federal cooperation hereinafter set forth and is willing to participate in the rehabilitation effort in accordance with the terms of this Agreement;

**NOW, THEREFORE**, the Government and the Public Sponsor agree as follows:

**ARTICLE I - DEFINITIONS AND GENERAL PROVISIONS**

For purposes of this agreement:

A. The term "Rehabilitation Effort" shall mean [DESCRIBE THE WORK TO BE UNDERTAKEN PURSUANT TO THIS AGREEMENT IN SUFFICIENT DETAIL AS IS NECESSARY TO AVOID ANY CONFUSION OVER WHAT WORK IS OR IS NOT INCLUDED], as generally described in a report entitled \_\_\_\_\_ [SPECIFY THE REPORT] prepared by the District Engineer, U.S. Army Engineer District \_\_\_\_\_, dated \_\_\_\_\_, and approved by the Division Engineer on \_\_\_\_\_.

B. The term "Rehabilitation Effort costs" shall mean all costs incurred by the Public Sponsor and the Government, in accordance with the terms of this Agreement, directly related to implementation of the Rehabilitation Effort. The term shall include, but is not necessarily be limited to, actual construction costs, including supervision and inspection costs; costs of contract dispute settlements or awards; and the cost of investigations to identify the existence of hazardous substances as identified in Article XIA. The term shall not include any costs for operation and maintenance; any costs that correct deferred or deficient maintenance; any increased costs for betterments or Public Sponsor preferred alternatives; or the costs of lands, easements, rights-of-way, relocations, or suitable borrow and dredged or excavated material disposal areas required for the Rehabilitation Effort.

C. The term "betterment" shall mean the design and construction of a Rehabilitation Effort feature accomplished on behalf of, or at the request of, the Public Sponsor, in accordance with standards that exceed the standards that the Government would otherwise apply for accomplishing the Rehabilitation Effort.

## **ARTICLE II - OBLIGATIONS OF THE GOVERNMENT AND PUBLIC SPONSOR**

A. The Government, subject to receiving funds appropriated by the Congress of the United States and using those funds and funds provided by the Public Sponsor, shall expeditiously implement the Rehabilitation Effort, applying those procedures usually followed or applied in Federal projects, pursuant to Federal laws, regulations, and policies. The Public Sponsor shall be afforded the opportunity to review and comment solicitations for all contracts, including relevant plans and specifications, prior to the issuance of such solicitations. The Contracting Officer will, in good faith, consider the comments of the Public Sponsor, but award of contracts, modifications or change orders, and performance of all work on the Rehabilitation Effort (whether the work is performed under contract or by Government personnel), shall be exclusively within the control of the Contracting Officer.

B. As further specified in Article III, the Public Sponsor shall provide all lands, easements, and rights-of-way, and suitable borrow and dredged or excavated material disposal areas, and perform all relocations determined by the Government to be necessary for construction, operation, and maintenance of the Rehabilitation Effort and the Project.

C. As further specified in Article IV, the Public Sponsor shall contribute, in cash, in-kind services, or a combination thereof, a contribution toward construction of the Rehabilitation Effort in an amount equal to 20 percent of total Rehabilitation Effort costs.

D. The Public Sponsor shall not use Federal funds to meet its share of total Rehabilitation Effort costs under this Agreement unless the Federal granting agency verifies in writing that the expenditure of such funds is expressly authorized by statute.

E. The Public Sponsor shall hold and save the Government free from all damages arising from the construction, operation, and maintenance of the Rehabilitation Effort, and any related betterments, except for damages due to the fault or negligence of the Government or the Government's contractors.

F. The Public Sponsor agrees to participate in and comply with the policies and procedures of the U.S. Army Corps of Engineers Rehabilitation and Inspection Program.

G. The Public Sponsor may request the Government to accomplish betterments. The Public Sponsor shall be solely responsible for any increase in costs resulting from the betterments and all such increased costs will be paid in advance by the Public Sponsor in accordance with Article IV.

### **ARTICLE III - LANDS, RELOCATIONS, DISPOSAL AREAS, AND PUBLIC LAW 91-646 COMPLIANCE**

A. The Government shall provide the Public Sponsor with a description of the anticipated real estate requirements and relocations for the Rehabilitation Effort. Thereafter, the Public Sponsor shall furnish all lands, easements, and rights-of-way, including suitable borrow and dredged or excavated material disposal areas, and perform any relocations, as may be determined by the Government in that description, or in any subsequent description, to be necessary for the construction, operation, and maintenance of the Rehabilitation Effort. The necessary lands, easements, and rights-of-way may be provided incrementally for each construction contract. All lands, easements, and rights-of-way determined by the Government to be necessary for work to be performed under a construction contract must be furnished prior to the solicitation of that construction contract.

B. The Public Sponsor shall comply with the applicable provisions of the Uniform Relocation Assistance and Real Property Acquisitions Policy Act of 1970, Public Law 91-646, as amended by Title IV of the Surface Transportation and Uniform Relocation Assistance Act of 1987 (Public Law 100-17), and the Uniform Regulations contained in 49 CFR Part 24, in acquiring lands, easements, and rights of way, and performing relocations for construction, operation, and maintenance of the Rehabilitation Effort, including those necessary for relocations, borrow materials, and dredged and excavated material disposal, and shall inform all affected persons of applicable benefits, policies, and procedures in connection with said Act.

### **ARTICLE IV - METHOD OF PAYMENT**

A. The Public Sponsor shall provide, during the period of construction, cash payments, in-kind services, or a combination thereof, required to meet the Public Sponsor's obligations under Article II of the Agreement. Rehabilitation Effort costs are currently estimated to be \$\_\_\_\_\_ and the Public Sponsor's share (cash and services in kind) of total Rehabilitation Effort costs is currently estimated to be \$\_\_\_\_\_. In order to meet the Public Sponsor's cash payment requirements, the Public Sponsor must provide a cash contribution estimated to be \$\_\_\_\_\_. The dollar amounts set forth in this paragraph are based upon the Government's best estimates that reflect projections of costs, price level changes, and anticipated inflation. Such cost estimates are subject to adjustments based upon costs actually incurred and are not to be construed as the total financial responsibilities of the Government and the Public Sponsor.

B. The required cash contribution shall be provided as follows: At least ten calendar days prior to the award of the first construction contract, the Government shall notify the Public Sponsor of the Public Sponsor's estimated share of the total Rehabilitation Effort costs including the Public Sponsor's estimated share of the costs attributable to the Rehabilitation Effort incurred prior to the initiation of construction.

Within five calendar days thereafter, the Public Sponsor shall provide the Government the full amount of the required contribution by delivering a check payable to "FAO, USAED \_\_\_\_\_" to the Contracting Officer representing the Government. The Government shall draw on the funds provided by the Public Sponsor such sums as the Government deems necessary to cover contractual and in-house fiscal obligations attributable to the Rehabilitation Effort as they are incurred, as well as Rehabilitation Effort costs incurred by the Government. In the event that Rehabilitation Effort costs are expected to exceed the estimate given at the outset of construction, the Government shall immediately notify the Public Sponsor of the additional contribution the Public Sponsor will be required to make to meet the Public Sponsor's share of the revised estimate. Within ten calendar days thereafter, the Public Sponsor shall provide the Government the full amount of the additional required contribution.

C. During the period of construction, the Government will provide periodic financial reports on the status of the total Rehabilitation Effort costs and status of contributions made by the Public Sponsor. Upon completion of the Rehabilitation Effort and resolution of all relevant contract claims and appeals, the Government shall compute the Rehabilitation Effort costs and tender to the Public Sponsor a final accounting of the Public Sponsor's share of Rehabilitation Effort costs.

1. In the event the total contribution by the Public Sponsor is less than the Public Sponsor's required share of total Rehabilitation Effort costs, the Public Sponsor shall, no later than 90 calendar days after receipt of written notice, make a cash payment to the Government of whatever sum is required to meet the Public Sponsor's required share of Rehabilitation Effort costs.

2. In the event total contribution by the Public Sponsor is more than the Public Sponsor's required share of Rehabilitation Effort costs, the Government shall, no later than 90 calendar days after the final accounting is complete, subject to the availability of funds, return the excess to the Public Sponsor; however, the Public Sponsor shall not be entitled to any refund for in-kind services. In the event the existing funds are not available to repay the Public Sponsor for excess contributions provided, the Government shall seek such appropriations as are necessary to repay the Public Sponsor for excess contributions provided.

#### **ARTICLE V - CREDITING OF IN-KIND SERVICES**

The Government has approved a credit for In-Kind Services, compatible with the Rehabilitation Effort, in the estimated amount of \$ \_\_\_\_\_ for implementation of such services by the Public Sponsor. The affording of such credit shall be subject to an onsite inspection by the Government to verify that the work was accomplished in a satisfactory manner and is suitable for inclusion in the Rehabilitation Effort. The actual amount of such credit shall be subject to an audit conducted to determine reasonableness, allocability, and allowability of costs. The Government shall apply the credit amount toward any additional cash contribution required under this Agreement. The Public Sponsor shall not receive credit for any amount in excess of such additional cash contribution, nor shall the Public Sponsor be entitled to any reimbursement for any excess credit amount.

#### **ARTICLE VI - OPERATION AND MAINTENANCE**

A. After the Contracting Officer has determined that construction of the Rehabilitation Effort is complete and provided the Public Sponsor with written notice of such determination, the Public Sponsor

shall operate and maintain the Project, at no cost to the Government, in accordance with specific directions prescribed by the Government in Engineer Regulation 500-1-1 and any subsequent amendments thereto.

B. The Public Sponsor hereby gives the Government a right to enter, at reasonable times and in a reasonable manner, upon land that the Public Sponsor owns or controls for access to the Project for the purposes of inspection, and, if necessary, for the purpose of completing, operating, and maintaining the Project. If an inspection shows the Public Sponsor for any reason is failing to fulfill the Public Sponsor's obligations under this Agreement without receiving prior written approval from the Government, the Government will send a written notice to the Public Sponsor. If, after 30 calendar days from receipt of such notice, the Public Sponsor continues to fail to perform, then the Government shall have the right to enter, at reasonable times and in a reasonable manner, upon lands the Public Sponsor owns or controls for access to the Project for the purposes of completing, operating, and maintaining the Project, or to deny further assistance under Public Law 84-99. No action by the Government shall operate to relieve the Public Sponsor of responsibility to meet the Public Sponsor obligations as set forth in this Agreement, or to preclude the Government from pursuing any other remedy at law or equity to assure faithful performance pursuant to this Agreement.

#### **ARTICLE VII - FEDERAL AND STATE LAWS**

In the exercise of the Public Sponsor's rights and obligations hereunder, the Public Sponsor agrees to comply with all applicable Federal and state laws and regulations.

#### **ARTICLE VIII - RELATIONSHIP OF PARTIES**

The Government and the Public Sponsor act in an independent capacity in the performance of their respective functions under this Agreement, and neither party is to be considered the officer, agent, nor employee of the other.

#### **ARTICLE IX - OFFICIALS NOT TO BENEFIT**

No member of or delegate to the Congress, or resident commissioner, shall be admitted to any share or part of this Agreement, or to any benefit that may arise therefrom.

#### **ARTICLE X - COVENANT AGAINST CONTINGENT FEES**

The Public Sponsor warrants that no person or selling agency has been employed or retained to solicit or secure this Agreement upon agreement or understanding for a commission, percentage, brokerage, or contingent fee, excepting bona fide employees or bona fide established commercial or selling agencies maintained by the Public Sponsor for the purpose of securing business. For breach or violation of this warranty, the Government shall have the right to annul this Agreement without liability, or, in the Government's discretion, to add to the Agreement or consideration, or otherwise recover, the full amount of such commission, percentage, brokerage, or contingent fee.

#### **ARTICLE XI - TERMINATION OR SUSPENSION**

If at any time the Public Sponsor fails to carry out its obligations under this Agreement, the District Engineer shall terminate or suspend work on the Rehabilitation Effort, unless the District Engineer determines that continuation of work on the Rehabilitation Effort is in the interest of the United States or is necessary in order to satisfy agreements with any other non-Federal interests in connection with this Rehabilitation Effort and Project. However, deferral of future performance under this agreement shall not affect existing obligations or relieve the parties of liability for any obligation previously incurred. In the event that either party elects to terminate this Agreement pursuant to this Article, both parties shall conclude their activities relating to the Rehabilitation Effort and proceed to a final accounting in accordance with Article IV of this Agreement. In the event that either party elects to defer future performance under this Agreement pursuant to this Article, such deferral shall remain in effect until such time as either the Government or Public Sponsor elects to proceed with further construction or terminates this Agreement.

#### **ARTICLE XII - HAZARDOUS SUBSTANCES**

A. After execution of this Agreement and upon direction by the Contracting Officer, the Public Sponsor shall perform, or cause to be performed, such investigations for hazardous substances as are determined necessary by the Government of the Public Sponsor to identify the existence and extent of any hazardous substances regulated under the Comprehensive Environmental Response, Compensation, and Liability Act (CERCLA) 42 U.S.C. Sections, 9601-9675, on lands necessary to Rehabilitation Effort construction, operation, and maintenance. All actual costs incurred by the Public Sponsor that are properly allowable and allocable to performance of any such investigations for hazardous substances shall be included in total Rehabilitation Effort costs and cost shared as a construction cost.

B. In the event it is discovered through an investigation for hazardous substances or other means that any lands, easements, rights-of-way, or disposal areas to be acquired or provided for the Project or the Rehabilitation Effort contain any hazardous substances regulated under CERCLA, the Public Sponsor and the Government shall provide prompt notice to each other, and the Public Sponsor shall not proceed with the acquisition of lands, easements, rights-of-way, or disposal areas until mutually agreed.

C. The Government and the Public Sponsor shall determine whether to initiate construction of the Rehabilitation Effort, or, if already in construction, to continue with construction of the Rehabilitation Effort, or to terminate construction of the Rehabilitation Effort for the convenience of the Government in any case where hazardous substances regulated under CERCLA are found to exist on any lands necessary for the Rehabilitation Effort. Should the Government and the Public Sponsor determine to proceed or continue with the construction after considering any liability that may arise under CERCLA, the Public Sponsor shall be responsible, as between the Government and the Public Sponsor, for any and all necessary clean up and response costs, to include the costs of any studies and investigations necessary to determine an appropriate response to the contamination. Such costs shall not be considered a part of the total Rehabilitation Effort costs as defined in this Agreement.

In the event the Public Sponsor fails to provide any funds necessary to pay for clean up and response costs or to otherwise discharge the Public Sponsor's responsibilities under this paragraph upon direction by the Government, the Government may either terminate or suspend work on the Rehabilitation Effort or proceed with further work as provided in Article X of this Agreement.

D. The Public Sponsor and Government shall consult with each other to assure that responsible parties bear any necessary clean up and response costs as defined in CERCLA. Any decision made pursuant to paragraph C of this Article shall not relieve any party from any liability that may arise under CERCLA.

E. As between the Government and the Public Sponsor, the Public Sponsor shall be considered the operator of the Project (which the Rehabilitation Effort is repairing and restoring) for purposes of CERCLA liability. To the maximum extent practicable, the Public Sponsor shall operate and maintain the Project in a manner that will not cause liability to arise under CERCLA.

**ARTICLE XIII - NOTICES**

A. All notices, requests, demands, and other communications required or permitted to be given under this Agreement shall be deemed to have been duly given if in writing and delivered personally, given by prepaid telegram, or mailed by first-class (postage prepaid), registered, or certified mail, as follows:

If to the Public Sponsor:

\_\_\_\_\_  
\_\_\_\_\_  
\_\_\_\_\_

If to the Government:

District Engineer

\_\_\_\_\_  
\_\_\_\_\_

B. A party may change the address to which such communications are to be directed by giving written notice to the other party in the manner provided in this Article.

C. Any notice, request, demand, or other communication made pursuant to this Article shall be deemed to have been received by the addressee at such time as it is either personally delivered, or, seven calendar days after it is mailed, as the case may be.

**IN WITNESS HEREOF**, the parties hereto have executed this Agreement, which shall become effective upon the date it is signed by the District Engineer.

THE DEPARTMENT OF THE ARMY

BY: \_\_\_\_\_

[SIGNATURE]

[TYPED NAME]

[TITLE IN FULL]

DATE: \_\_\_\_\_

THE [NAME OF PUBLIC SPONSOR]

BY: \_\_\_\_\_

[SIGNATURE]

[TYPED NAME]

[TITLE IN FULL]

DATE: \_\_\_\_\_

**CERTIFICATION REGARDING LOBBYING**

The undersigned certifies, to the best of his or her knowledge and belief that:

(1) No Federal appropriated funds have been paid or will be paid, by or on behalf of the undersigned, to any person for influencing or attempting to influence an officer or employee of any agency, a Member of Congress, an officer or employee of Congress, or an employee of a member of Congress in connection with the awarding of any Federal contract, the making of any Federal grant, the making of any Federal loan, the entering into of any cooperative agreement, and the extension, continuation, renewal, amendment, or modification of any Federal contract, grant, loan, or cooperative agreement.

(2) If any funds other than Federal appropriated funds have been paid or will be paid to any person for influencing or attempting to influence an officer or employee of any agency, a Member of Congress, an officer or employee of Congress, or an employee of a member of Congress in connection with this Federal contract, grant, loan, or cooperative agreement, the undersigned shall complete and submit Standard Form-LLL, "Disclosure Form to Report Lobbying," in accordance with its instructions.

(3) The undersigned shall require that the language of this certification be included in the award documents for all subawards at all tiers (including subcontracts, subgrants, and contracts under grants, loans, and cooperative agreements) and that all subrecipients shall certify and disclose accordingly.

This certification is a material representation of fact upon which reliance was placed when this transaction was made or entered into. Submission of this certification is a prerequisite for making or entering into this transaction imposed by section 1352, title 31, U.S. Code. Any person who fails to file the required certification shall be subject to a civil penalty of not less than \$10,000 and not more than \$100,000 for each such failure.

DATED this \_\_\_\_\_ day of \_\_\_\_\_, 20\_\_\_\_\_

\_\_\_\_\_  
[SIGNATURE OF CA SIGNATORY]  
[TYPED NAME]  
[TYPED TITLE]



# APPENDIX G: COOPERATION AGREEMENT FOR FLOOD FIGHT

## COOPERATION AGREEMENT BETWEEN THE UNITED STATES OF AMERICA and

\_\_\_\_\_

### for EMERGENCY ASSISTANCE (FLOOD or COASTAL STORM)

**THIS AGREEMENT**, entered into this \_\_\_\_ day of \_\_\_\_\_, 20\_\_\_\_, by and between THE DEPARTMENT OF THE ARMY (hereinafter referred to as the "Government") acting by and through the District Engineer, \_\_\_\_\_ District, U.S. Army Corps of Engineers, and the \_\_\_\_\_ [PUBLIC SPONSOR], (hereinafter referred to as the "Public Sponsor"), acting by and through \_\_\_\_\_ [TITLE OF PERSON SIGNING THIS AGREEMENT].

#### WITNESSETH THAT:

**WHEREAS**, Public Law 99, 84th Congress, approved 28 June 1955, authorizes the Chief of Engineers to flood fight and perform rescue operations.

**WHEREAS**, the Public Sponsor has requested assistance under Public Law 84-99, and the Public Sponsor qualifies for assistance in accordance with the established policies of the U.S. Army Corps of Engineers.

**NOW, THEREFORE, the parties agree** as follows:

1. The Government will perform the work described in its scope of work (attached) that is made part of this agreement.
2. The Public Sponsor agrees, in consideration of the Government providing assistance, to fulfill the requirement of non-Federal cooperation required by the U.S. Army Corps of Engineers regulations, to wit:
  - a. Provide without cost to the Government all lands, easements, rights-of-ways, borrow material, and disposal areas necessary for the authorized work, for the use of borrow areas and/or spoil areas, and for access to and from the site(s) of the structure(s) or work area(s), the borrow sites, and spoil areas.
  - b. Hold and save the Government free from damages due to the authorized work, except damages due to the fault or negligence of the Government or its contractors.
  - c. Maintain and operate the completed work in a manner satisfactory to the Government.
3. The Public Sponsor further agrees to remove, at no cost to the U.S. Army Corps of Engineers, all temporary work constructed by the Government; and,
  - a. (Add others as applicable)
4. Additional obligation under the terms of this agreement terminates when the authorized work performed by the Government is completed.
5. ATTACHMENTS:
  - a. Exhibit A - Government Scope of Work.
  - b. (Add others as applicable)

**IN WITNESS WHEREOF**, the parties hereto have executed this agreement of the day and year first above written.

**THE DEPARTMENT OF THE ARMY**

**THE [NAME OF PUBLIC SPONSOR]**

This page intentionally left blank.

# APPENDIX H: COOPERATION AGREEMENT FOR ADVANCE MEASURES ASSISTANCE

**COOPERATION AGREEMENT  
BETWEEN  
THE UNITED STATES OF AMERICA  
and**

-----  
**for  
ADVANCE MEASURES ASSISTANCE**

**THIS AGREEMENT**, entered into this \_\_\_\_\_ day of \_\_\_\_\_, 20\_\_\_\_\_, by and between THE DEPARTMENT OF THE ARMY (hereinafter referred to as the "Government") represented by the District Engineer, \_\_\_\_\_ District, U.S. Army Corps of Engineers, and the \_\_\_\_\_ [PUBLIC SPONSOR], (hereinafter referred to as the "Public Sponsor"), represented by \_\_\_\_\_ [TITLE OF PERSON SIGNING THIS AGREEMENT].

**WITNESSETH THAT:**

**WHEREAS**, 33 U.S.C. 701n authorizes the Chief of Engineers to provide Advance Measures.

**WHEREAS**, the Public Sponsor has requested, in writing, assistance under 33 U.S.C. 701n and qualifies for such assistance in accordance with the established policies of the U.S. Army Corps of Engineers; and,

**WHEREAS**, the Public Sponsor hereby represents that it has the authority and legal capability to furnish the non-Federal cooperation hereinafter set forth and is willing to participate in accordance with the terms of this agreement.

**NOW, THEREFORE, the parties agree** as follows:

1. The Government will perform the work described in its scope of work, which is made part of this agreement.
2. The Public Sponsor will:
  - a. Provide without cost to the Government all lands, easements, rights-of-ways, relocations, and borrow and dredged or excavated material disposal areas necessary for the work.

b. Hold and save the Government free from damages arising from construction, operation, maintenance, repair, replacement, and rehabilitation of the work, except damages due to the fault or negligence of the Government or its contractors.

c. Operate, maintain, repair, replace, and rehabilitate the completed work in a manner satisfactory to the Government; and

d. Remove all temporary work constructed by the Government, with initiation of removal within 30 days of the conclusion of the flood event.

3. The Public Sponsor further agrees to: (Add as applicable)

4. ATTACHMENTS:

a. Exhibit A - Written request for assistance from the Public Sponsor.

b. Exhibit B - Government Scope of Work.

c. Add others as applicable.

**IN WITNESS WHEREOF**, the parties hereto have executed this agreement of the day and year first above written.

**THE DEPARTMENT OF THE ARMY**

**THE [NAME OF PUBLIC SPONSOR]**

BY: \_\_\_\_\_

BY: \_\_\_\_\_

[SIGNATURE]  
[TYPED NAME]  
[TITLE IN FULL]

[SIGNATURE]  
[TYPED NAME]  
[TITLE IN FULL]

ADDRESS:

ADDRESS:

## **APPENDIX I: USEFUL LINKS**

### **Organizations:**

<http://www.usace.army.mil>

Homepage of the U.S. Army Corps of Engineers. All districts and divisions are linked through this page, and can be accessed through alphabetical listings and through clicking on a map of the United States. Emergency Management Offices are accessible through division and district home pages.

<http://www.fema.gov>

Homepage of the Federal Emergency Management Agency.

<http://www.nws.noaa.gov/>

National Weather Service Website. If you click on the “Rivers” tab, you can view river gage information.

### **Laws and Regulations:**

<http://uscode.house.gov/>

Searchable database of the US Code (Public Laws)

<http://www.gpoaccess.gov/cfr/index.html>

The Code of Federal Regulations Main Page

<http://www.usace.army.mil/inet/usace-docs/>

Publications of the Army Corps of Engineers Headquarters. There are a number of Corps publications that may provide additional guidance in the operation, maintenance or preferable design of flood control works. Some specific references are listed in Chapter 1 of this manual.

## Other Useful Information:

[http://www.nwk.usace.army.mil/local\\_protection/guidance.html](http://www.nwk.usace.army.mil/local_protection/guidance.html) This site has a lot of information that the Corps' geotechnical engineers have assembled for public use. It gives more detailed guidance on many topics, such as running utilities over and through a levee, power poles, slope protection, gates, and a number of other related topics.

<http://www.nws.usace.army.mil/PublicMenu/Menu.cfm?sitename=em&pagename=Floodfi>

This Corps site has presentations and brochures on sandbagging.

<http://chl.ercd.usace.army.mil/ffs> This website, "Laboratory and Field Testing of Temporary Barrier Type Flood Fighting Products," provides information the Corps has gathered on alternative flood fight technologies. There are several innovative flood fight products that the Corps has tested, and the results are publicly available on this site.

<http://www.crrel.usace.army.mil/icejams/index.htm>

This Corps site provides information on ice jams.

<http://www.gnb.ca/0009/0369/0004/>

While this website is specific to New Brunswick, Canada, it is another very good source of information on ice jams.

[http://chl.wes.army.mil/research/hydstruc/bankprotect/scm\\_guide\\_screen.pdf](http://chl.wes.army.mil/research/hydstruc/bankprotect/scm_guide_screen.pdf)

The Kansas River and Stream Corridor Management Guide presents some good general information on channels, erosion control measures, and other topics related to watershed management.

<http://www.fema.gov/fima/>

Of particular note on the FEMA webpage is the Mitigation Division homepage. This page has a lot of useful information on flood insurance and grant programs. It also includes a searchable database of best practices and case studies, [http://www.fema.gov/mitigationss/sstory\\_find\\_gui.do](http://www.fema.gov/mitigationss/sstory_find_gui.do) If you select "Flooding" as a hazard, and "Flood Control" as a category, you can find a number of success stories of flood control works from around the country. This database also includes some good examples of relocations and non-structural alternatives to flooding problems.





**US Army Corps  
of Engineers®**